

THE EFFECTS OF DIFFERENTIATED INSTRUCTION BASED ON MULTIPLE
INTELLIGENCES WITH AP CHEMISTRY STUDENTS

by

Elaine Gibbs

A professional paper submitted in partial fulfillment
of the requirements for the degree

of

Master of Science

in

Science Education

MONTANA STATE UNIVERSITY
Bozeman, Montana

July 2014

STATEMENT OF PERMISSION TO USE

In presenting this professional paper in partial fulfillment of the requirements for a master's degree at Montana State University, I agree that the MSSE program shall make it available to borrowers under rules of the program.

Elaine Gibbs

July 2014

DEDICATION

I am dedicating this paper to my family. Ann Duncan and Gary Cunningham for raising me to believe in myself and my abilities to do anything. My daughters, Savannah, Hannah, and Gigi, for showing me the world that I didn't know existed. Camille Gasaway Hernandez Pace for showing me the path and being by my side every step of the way, whether she was a foot away or on another continent. I love each of you for everything you have given to me.

TABLE OF CONTENTS

| | |
|---|----|
| INTRODUCTION AND BACKGROUND | 1 |
| CONCEPTUAL FRAMEWORK..... | 3 |
| METHODOLOGY | 10 |
| DATA AND ANALYSIS..... | 17 |
| INTERPRETATION AND CONCLUSION | 35 |
| VALUE..... | 38 |
| REFERENCES CITED..... | 42 |
| APPENDICES | 44 |
| APPENDIX A: Lesson Materials | 45 |
| APPENDIX B: Multiple Intelligence Student Test | 57 |
| APPENDIX C: Pre and Post Assessments..... | 60 |
| APPENDIX D: Pre and Post Unit Student Concept Interviews | 63 |
| APPENDIX E: Pretreatment and Posttreatment Student Survey | 65 |
| APPENDIX F: Pretreatment and Posttreatment Student Interview Questions and Delayed Questions | 67 |
| APPENDIX G: Student Journal Prompts | 69 |
| APPENDIX H: Teacher Journal | 72 |
| APPENDIX I: Classroom Observation Instrument | 74 |
| APPENDIX J: Nontreatment and Treatment Observations by Colleagues with Prompts | 78 |
| APPENDIX K: Pretreatment and Posttreatment Teacher Survey | 81 |
| APPENDIX L: Project Timeline | 83 |

LIST OF TABLES

| | |
|--|----|
| 1. Data Triangulation Matrix | 15 |
| 2. Average Pre and Postunit Assessment Scores | 18 |
| 3. Average Pre and Postunit Concept Map Scores | 20 |
| 4. Average Post and Delayed unit Assessment Scores | 24 |

LIST OF FIGURES

| | |
|---|----|
| 1. Multiple Intelligences Profiles of Students..... | 17 |
| 2. Student Confidence Levels in Understanding..... | 22 |
| 3. Delayed Student Survey Responses on Remembering | 25 |
| 4. Delayed Student Survey Responses on Confidence | 26 |
| 5. Student Level of Engagement based on Enjoyment | 27 |
| 6. Student Level of Engagement based on Peer Engagement..... | 28 |
| 7. Student Level of Engagement based on Anticipation..... | 29 |
| 8. Teacher Survey and Journal Results | 31 |
| 9. Multiple Intelligence Average Assessment Results..... | 32 |
| 10. Multiple Intelligence Survey Questions Treatment Unit 1 | 33 |
| 11. Kinesthetic Survey Results | 34 |
| 12. Spatial Survey Results | 34 |

ABSTRACT

This study investigated the utilization of differentiated instructional activities and lessons based on student's profile of multiple intelligences on understanding concepts, low-level achieving student understanding, delayed remembering, engagement of student and teacher perception. Students were grouped in homogeneous sets based on their highest intelligence for an introductory lesson and for subsequent lessons students worked collaboratively in integrated heterogeneous groups. The method of collection for data were assessments, concept interviews, student interviews, student surveys, student journal prompts, teacher journal, classroom observations by teacher and colleague, and teacher survey. The results were positive for the lower achieving group's understanding of concepts, engagement of the entire class, and teacher self-perception.

INTRODUCTION AND BACKGROUND

During the third quarter of each year, the students appear tired and lost while covering some of the most complex Advanced Placement (AP) Chemistry concepts for the AP Exam. Because the material is cumulative, it is not feasible to rearrange the order of the topics. To regain the focus of these students and recharge their learning, I chose a project uniting differentiated instruction techniques based on Howard Gardner's multiple intelligences. The purpose was to refocus students' efforts in my AP Chemistry class during their final quarter before review for the AP exam. The multiple intelligence theory focuses on the ease in learning in a person's strongest intelligence, such as kinesthetic/ bodily or mathematical/ logical. By restructuring the presentation of unit material based on their strongest intelligence and grouping them homogeneously, I hoped the students would build a good base knowledge of the unit. For the second part of the project, the students were grouped collaboratively in heterogeneous groups. This enabled the students to work cooperatively and build on each other's knowledge while continuing with the unit material. This project was important to the students as a course-specific academic challenge. Moreover, their success in the AP class potentially offers them college credit for their work. The improvements made by AP Chemistry students were important to our final yearly school grade, which is based partly on their AP scores. The project could possibly serve as a model for other teachers on the many ways differentiated instruction can be incorporated into their classroom.

I taught at an urban magnet high school with a science, technology, engineering and math (STEM) focus. The majority of the students were bused from the entire county, one and half hour bus ride each way to school. Seventy percent of the school's population

were categorized under the free and reduced lunch program. Our school has a Title 1 status, a federal program that provides additional funding for student enrichment. The students in my study were predominately from the magnet program and a large percentage of those were first-year chemistry students.

My project focus question was, what are the effects of utilizing multiple intelligences (MI)-guided differentiated activities on student understanding of Advanced Placement Chemistry concepts? My project subquestions were as follows: what are the effects of utilizing MI-guided differentiated activities on the understanding of concepts by low-achieving students; what are the impacts of utilizing multiple intelligences-guided differentiated instructions on long-term memory; what are the impacts of utilizing multiple intelligences-guided differentiated instructions on student engagement; and what are the effects of using multiple intelligences-guided differentiated instructions on my self-perception of accomplishment?

Differentiated Instruction (DI) is the basis of taking a lesson on one concept and presenting it in different forms to students. Differentiation can be accomplished through content, process or product as noted by Gregory and Herndon (2010). The DI structure can be constructed on three bases of instruction through readiness, interests, and learning profiles (Llewellyn, 2011). DI based on readiness is changing presentation of the lesson based on the students ability to handle more advanced content. In my interpretation, if the teacher designs a lesson based on the student's interests, it would be a custom fit to what the student values and finds interesting. Differentiated instruction can be described as modifying lessons or activities to tailor fit a smaller group of students within a class. In this case, I changed the presentation of unit concepts based on students' multiple

intelligences. Multiple intelligence is a theory based on how an individual best learns. Each person has a primary intelligence out of eight possibilities: verbal/linguistic, musical/rhythmic, logical/mathematical, visual/spatial, bodily/kinesthetic, naturalist, intrapersonal and interpersonal (Gardner, 1983). Most of the students had a strong logical/mathematical intelligence. The intrapersonal, interpersonal, musical/rhythmic, and naturalist strengths were not being incorporated at this time. I chose to group the students by verbal/linguistic, visual/spatial or bodily/kinesthetic. The groupings are based on their strongest intelligence in one of those three. As stated by Mokhtar (2008), “An individual is expected to be more receptive to learning if his dominant intelligence is used as a catalyst to encourage more effective learning” (p.196).

I had my Committee chair: Dr. Peggy Taylor, Montana State University Masters of Science in Science Education (MSSE) Program Director, my MSSE Core and Capstone Advisor: Jewel Reuter, Ph.D. of MSU and my MSU project reader, Dr. Chris Bahn, as my MSSE Capstone Graduate Committee. My support team for this project was Ms. Robertson, an English teacher at my school, who was crucial in my writing and editing process. Erica Danahee was a recent graduate of her master’s degree in education and very knowledgeable in pedagogy and curriculum. I was also assisted by my daughters, Hannah and Savannah Gibbs who are current high school students and gave feedback from the perspective of the student as well as fluidity of the language in the project.

CONCEPTUAL FRAMEWORK

The literature review was based on three general areas: multiple intelligences, differentiated instruction, and classroom applications. The literature revealed the general

trend of increased usage of MI as a way to develop DI in lesson planning. I found literature addressing differentiated instructional techniques based on MI from varying classrooms levels, but the most enlightening and resourceful was from Brown's college freshman chemistry classroom (Brown, 2004).

The areas of intelligence have been studied for many years. For the last 100 years, intelligence has been thought of as either low, middle, or high based on a series of intelligence quotient tests. Howard Gardner (2008) defines intelligence in his speech, "As for my definition: an intelligence is a biopsychological potential to process information in certain kinds of ways, in order to solve problems or create products that are valued in one or more cultural settings" (p.3). It was additionally theorized that individuals have preferences in learning styles, as it was easier for an individual to learn with either an audio, visual or hands-on (kinesthetic) approach to any particular topic. In 1983, Gardener published his MI theory that was meant for the behavioral sciences audience but was soon adopted and utilized in the education arena. Many psychologists that read his work were apprehensive of his theory due to his lack of experimental evidence. Gardner's theory defines intelligence as the way in which a person learns, rather than how smart a person may be. This theory supports my idea that any student is capable of learning difficult concepts; it is a matter of approach in presenting AP Chemistry concepts that makes a difference in the understanding.

Understanding the AP Chemistry concepts was addressed in research on high school science students. As noted by Meers and Wiseman (2002), "Expansion of the definition of intelligence from logical/mathematical and verbal/linguistic to include the

other multiple intelligences would enhance opportunities for students to perform in domains that allow them to demonstrate their abilities” (p.31). In my opinion, using more intelligences coupled with DI in a science classroom allows the student an increased chance of understanding. Rather than exclusively using and ‘lecture and homework’ method, having the student apply the science concept through a lesson based on MI and DI gives a deeper understanding. This type of change in lesson construction is supported by the upcoming changes in the AP Chemistry curriculum for 2013-2014 and is outlined in an article by Rushton (2012). He states the following:

I see this move by the College Board as a challenge to both the K–12 and the higher education community alike. For AP chemistry teachers using a traditional lecture and discussion, textbook-based approach as I did early in my career, this paradigm shift in curricular focus most likely will demand a similar evolution in pedagogy, discourse models, and assessment practices if their students can be expected to perform well on future AP exams. For the AP students who have been “good” at school mostly because of their ability to memorize large quantities of decontextualized material or crunching numbers in algebraic equations, the expectation to synthesize, evaluate, justify, and connect fundamental ideas in chemistry may be perceived as a significant (and unwelcome) change in the way school is “played”. (p. 692)

It was anticipated that AP chemistry students in my capstone project would be aided by (MI and DI) to help with their successful synthesis of the content and may be helpful to prepare the students for the redesigned AP exam, which requires the use of higher order thinking.

In another study involving high school science, Meers and Wiseman (2002) addressed understanding concepts with respect to achievement levels. They used DI for their entire class structure and based this on their MI. These class structures increased students' performance. Meers and Wiseman (2002) stated, "Students who had encountered failure or who struggled in theoretical courses were placed in the courses using applied methodology" (p. 30). This was successful because of their use of MI. Meers and Wiseman state, "Pre-assessing students for their multiple intelligences and placing them appropriately in science courses corresponding to the profiles identified in this study would increase student potential for achievement, while reducing their frustration levels" (p. 31). Their project resulted in a successful implementation of physics displays in a local museum based on their class MI and DI of the project construction. By identifying their MI and applying that foundation to the building of DI instruction, Meers and Wiseman gave their students the ability to achieve a goal that may have once been out of their reach through traditional class placement.

It was also proven that DI lessons are advantageous in improving student's long-term memory. Research performed by Bunce, VandenPlas, and Soulis (2001) showed a retention of knowledge among high school chemistry students to be higher than college students. This was correlated to the spiral method. Students were engaged in reviewing the material repeatedly. The spiral method linked to my project approach because the students were engaged in heterogeneous groups for the remainder of lessons on each unit after their initial exposure in their primary intelligence. This method design would have them repeating the same material to each other to gain understanding through interpretations by other intelligences. Bunce et al. (2011) stated the following, "students

are presented with information on a need-to-know basis but concepts are revisited several times during a chapter or over several chapters, providing more detail and links to prior learning each time” (p. 1232). Through this repetition, students are repeatedly exposed to the same material and lay a pathway for recalling that information from their long-term memory instead of their short-term memory. This was correlated through MI because the way a student learns is just as important as what they are learning. A student’s MI profile does not dictate the ability to store information in short or long-term memory but that there is an increased chance of gaining the knowledge if the initial exposure to the concept is in their primary intelligence.

DI instruction based on MI is also useful in the classroom for improved student engagement. In one article the researcher, Suarez (2002), was working in an elementary social studies classroom and saw good results in engagement with her poorly motivated students. Her principal actually asked why her students weren’t being sent to his office during her class period. She had based her lessons on each MI and modeled each intelligence in the classroom. The student’s understanding of their MI strengths gave the student a better cooperative focus in the classroom. Student engagement regardless of age affects discipline and attitude of students in class. One study of AP teachers using DI groups allowed them to tailor the lesson while maintaining the flow under a time limit (Waller, 2011). Waller (2011) notes “The participants stated that these elements of differentiated instruction help to motivate the students and allowed students to take ownership in their work” (p.91). The use of DI helps keep the student engaged while tackling more difficult concepts as often encountered in an AP level course.

In terms of methods used to teach MI, my study was most consistent with Wright's (2004). Their methodology and my treatments were identical, and also used the three methods; audio, visual, and kinesthetic, before general lecture and classroom sessions. I grouped my students by their MI strength for an initial unit lesson. Then, I followed with lessons of lectures, homework examples and lab exercises with heterogeneous groups. This builds on the Gardner philosophy of exposure in the student's intelligence strength followed by exposure to the other intelligences. Gardner (2008) states:

Pluralized education exemplifies what it means to understand something well. Because if you understand an entity well—be it a school subject, an avocation, your own home, your own family—you can think of it in many ways. Conversely, if you can only represent this entity in a single way, using a single intelligence, then your own mastery is probably tenuous. (p.7)

Using MI theory to group students creates valuable and authentic learning opportunities and much of a teacher's success depends on their students' experience. Berman (2011) states "Another major problem with MI Theory is how difficult it is for the newly qualified and inexperienced teachers to put it into practice" (p.2). This is true with any new method, as a new teacher is overwhelmed by the position of teaching the first couple years in the classroom. Conversely, research by Ordover (2012) revealed teachers opinions of MI and its application in the classroom varies from novices to veterans. Veterans were resistant to adopting to change, whereas novice teachers were open to new strategies in instruction. Inflazoglu (2001) researched primary and secondary

teachers utilizing MI. The majority wanted to use it and valued it as a way to enhance presentation of material to students. However, teachers were not able to get full utilization of MI because of lack of training and content load. There was also a wide gap with increased gains between inexperienced and experienced teachers. Often, teachers in the secondary level were using MI strategies as homework instead of incorporating them into classroom lesson content. Garner (2008) states in his speech, “the most important educational implications of MI theory... can be captured in two words: Individuation and Pluralization”(p.6). These two words are the main encompassing factor that ties MI to DI. Teachers must tailor their lesson to their students’ intelligence but material must be presented in more than one way for deeper understanding in a classroom setting.

My literature review revealed that students exposed to DI are more engaged, have higher achievement scores and build a stronger knowledge of the concept. It is also noted that teachers using MI and DI feel more successful because of these outcomes. I expected that this may be difficult to manage in a small classroom but should enhance the instruction at a time when students are ready to quit. As stated by Rushton (2012):

Teachers of AP chemistry feeder courses will experience both internal and external pressures to prepare their students for this curriculum, and will need to ask themselves about the changes to their teaching philosophy that will be necessary to achieve these goals. (p.692)

This type of lesson construction would help address some of these pressures through the student’s ability to use more than one intelligence to address any chemistry concept.

METHODOLOGY

Project Treatment

There was a nontreatment unit followed by two treatment units. The nontreatment unit concept material was presented as it had been in the previous semester, flipped classroom notes, in-class lab and practice problems. For the treatment units, the students were split into homogeneous MI groups; spatial, linguistic, and bodily- kinesthetic, for an initial concept lesson and followed by heterogeneous groups in following lessons.

During the nontreatment unit, I presented the concept lessons in the following order: laboratory experiment, computer-based tutorials and/or PowerPoint presentation. A sample of each is in Appendix A. The lab consisted of background information, prelab questions, procedures and materials, data tables, and conclusion questions. The students were assigned in random groups for the lab activity. The computer- based tutorial was presented from the computer to the whole class. It was a supplement from a different textbook and based upon audio, visual simulations, and sample problems. The PowerPoint presentation was previously assigned; I had a flipped classroom, so it was only used as a review for the whole class. The students were allowed to work on problems if time is remaining in the block. The students were first assigned a lab that covers the concept of the unit. I lectured in the following class sessions with an online tutorial about the concepts covered. This gave a more in depth explanation, tied in with a good visual illustration and included a couple of practice problems. The PowerPoint was reviewed if there was time, during the period or before the test. On test day I collected the homework assignments and laboratory exercises for grading. The PowerPoint, laboratory write-up, and homework assignments were posted in their online accounts.

The treatment units were based upon their MI surveys (Armstrong). The MI surveys were administered online. The students submitted their results to me via their online school accounts or as a hard copy. I also had their parents take the MI survey for their student, which provided more support and credibility to the students' results from another viewpoint. A copy of the MI survey is found in Appendix B. Student groupings were based on those results and focus was given to the spatial, linguistic and bodily-kinesthetic rankings. The logical-mathematical, interpersonal and intrapersonal rankings were only considered in the heterogeneous groups to ensure cohesiveness. The students were placed in small groups of four or less, based on their highest MI. The students were split into three groupings; spatial, linguistic, and bodily-kinesthetic. Each group worked separately from the other groups during the initial class period. The bodily-kinesthetic group performed the laboratory exercise due to its hands-on approach. The linguistic group worked the homework problems with a copy of the PowerPoint, more of a logical approach. The spatial group sat with me and reviewed the tutorials based on the concept; the review was a dialogue between the students and me, audio from the tutorial and the interactive diagrams. The secondary treatment concept lessons were split into two parts; one part was lecture, problem and exercise and the other part was a demo of the laboratory. These secondary lessons, and all the following lessons, were based on mixed groups of MI. This approach allowed information to disseminate between students. The laboratory exercise was relayed to the other students in the heterogeneous MI group from the member that was in the original homogeneous bodily-kinesthetic group. A demonstration of the lab was performed either by me or one of the students. The data were shared from the original lab and members in each heterogeneous group helped each

other with their post-laboratory questions. The spatial students helped explained their ideas of the concept to the other students in their group from their gained knowledge of the tutorial or activity. The linguistic group, having already practiced application to actual problems, supported the new hetero group through their expanded insight from the homework problems. During the days following the initial lesson, I employed the Socratic Method by answering with higher order thinking questions to any questions or comments that arose from the mixed groups.

The material used for the laboratory exercises, PowerPoint and homework problems are all from APChem solutions. It is a package sold to AP Chemistry teachers to give students a strong background for the AP exam. Each concept within the package has a variety of laboratory write-ups and Power Point slides that are geared to cover exam topics. The linguistic MI groups were given a set of the PowerPoint lecture slides and a set of the homework problems to complete, see Appendix A. They used the example problems in the PowerPoint to guide themselves through the homework questions. The bodily-kinesthetic MI groups were given the laboratory write up and equipment, see Appendix A. They were instructed to perform the laboratory exercise and collect the data needed from the experiment. The spatial MI group reviewed an online computer tutorial of their concept with my direction. The group's leader followed the prompts and we discussed each problem question together while working it to completion. At the next class session, we regrouped into mixed MI groups and the groups reviewed the laboratory questions, homework questions, and additional PowerPoint materials. I facilitated group interaction with content questions through the use of higher order thinking questions. If I felt they had exhausted their knowledge, I entertained questions from each group to the

whole class. This happened toward the end of the class session. The remaining concepts were presented in mixed groups which included more labs and additional tutorials or lectures.

In employing Howard Gardner's theory on using the strongest intelligence to build a foundation for knowledge and utilizing the other intelligences to tier that understanding higher, students should have had a wide breadth of exposure to each concept. In building a deeper understanding of content, students should have retained more knowledge. The movement from homogeneous to heterogeneous groups, as well as from self to group reflection, should have kept students engaged in the learning process. By having the students experience each concept in a triple exposure and through student interactions and discussion, students should have utilized prior knowledge and gained a more detailed understanding of the concept.

Data Collection Instruments

I teach at an urban magnet high school with a STEM (science, technology, engineering and math) focus. The students traveled by bus from all over the county. Our school has a student enrollment of 1,200 students for grades 9-12 located in a low income area in the inner city limits of Tampa, Florida. Our school population is 70% free and reduced lunch and our school had a Title I status. Title I is grant money given from the federal government to provide opportunities to disadvantaged students. The students in my study were predominately from the magnet program and a large percentage of them were first year chemistry students. My AP Chemistry class had 18 students of 10th, 11th and 12th graders. There were fourteen 10th graders that had never had high school chemistry before taking AP Chemistry. The class was made of 12 males and 8 females

with a variety of races, including White (10 students), Black (5 students) Hispanic (2 students), Multiracial (1 student), and Asian or Pacific Islander (2 students). The students are hardworking and driven, although a few need help with motivation and discipline to achieve success in learning.

I collected data from various sources. I provided students with pre and postunit assessments and pre and postunit student concept interviews, as well as a delayed assessment to quantify their increase and retention in knowledge of the content, see Appendix C and Appendix D respectively. I also quantified their perception of using multiple intelligences to group them through a student survey, see Appendix E. I used individual student interviews to gather qualitative information about the MI groupings and their perception of achievement and engagement, see appendix F. Data were grouped by overall classroom grades and categorized into high, medium, and low-achievement levels. I chose two students from each achievement level in order to address concerns at each level. These interviews were conducted outside the classroom in the library. I utilized student and teacher journal entries to gain a deeper insight into their and my discernment of the project subquestions, see Appendix G and Appendix H, respectively. The student journal prompts are to see the gained insight from that day's lesson. I also collaborated with a fellow teacher to make observations of my class and myself during the project. Please refer to Table 1 for the data triangulation matrix.

Table 1
Data Triangulation Matrix

| Focus Question | Data Source 1 | Data Source 2 | Data Source 3 |
|--|---|--|--|
| <i>Primary Question:</i> | | | |
| What are the effects of utilizing multiple intelligences-guided differentiated activities on student understanding of Advanced Placement Chemistry concepts? | Pre and postunit student capstone project target assessments | Pre and posttreatment student surveys | Pre and postunit student concept interviews |
| <i>Subquestions:</i> | | | |
| What are the effects of utilizing multiple intelligences-guided differentiated activities on the understanding of concepts by low-achieving students? | Pre and postunit student capstone project target assessments | Pre and posttreatment student surveys | Student Journals |
| What is the impact of utilizing multiple intelligences-guided differentiated instructions on long-term memory? | Postunit and delayed unit student capstone project target assessments | Postunit and delayed unit student concept interviews | Posttreatment and delayed student surveys |
| What are the impacts of utilizing multiple intelligences-guided differentiated instructions on engagement? | Pre and posttreatment student interviews | Pre and posttreatment student surveys | Instructor observations with field notes |
| What are the effects of using multiple intelligences-guided differentiated instructions on my self-perception of accomplishment? | Teacher Journal with prompts | Pre and posttreatment teacher surveys | Nontreatment and treatment observations by colleagues with prompts |

I conducted a student survey with questions and the students answered in written responses that I collected. I gave students a written copy of the survey so that they could make notes about the open-ended questions and give the survey back to me. This gave me a general idea of how the class as a whole responded to the homogeneous grouping by MI followed by the heterogeneous grouping for the rest of the concept lessons. I also wanted

to gauge their engagement and their interpretation of performance before I graded their assessments. I followed the survey with a few individual face-to-face interviews, to get some more in-depth feedback from individual students. I conducted interviews specifically targeting high, medium and low-achieving students. At least two students from each category gave enough depth to the feedback. I did not limit the interviews, after the two were selected and I accepted any additional volunteers. The interview data were collected by me via notes in my laptop. I conducted the surveys and nonconcept interviews following the conclusion of the last concept unit in February. The delayed results gave me time to survey and interview the class, as well as review the data and ask additional questions if the evidence was unclear in the analysis. There were also classroom observations of the treatment and nontreatment units from an observer. The data table used for this is contained in Appendix I and additional observations collections were collected using prompts, see Appendix J. The teacher data collection was through a teacher survey, Appendix K, and teacher journal prompts. The teacher data collection instruments allowed insight into teacher perception from a qualitative and quantitative data set and was collected many times in each nontreatment and treatment unit. The general timeline is contained in Appendix L. There is a large break in the timeline due to exam review and exams being given the first two weeks in January. The second semester began with the treatment units. This break also allowed me time to send home the multiple intelligence surveys to students' parents during the winter break. The research methodology for this project received an exemption by Montana State University's Institutional Review Board and compliance for working with human subjects was

maintained. I organized the MI groups during the exam week. The analysis and reflection were concluded in the last weeks.

DATA ANALYSIS

Determining the effects of DI based on MI presented some correlations on their performance and their primary MI. Unexpectedly, as compared to previous years, my students MI profiles were not predictable. None of my students had a high linguistic intelligence, meaning it was not one of their top three MI. Also, spatial intelligence tended to be rated low. I also had a few students whose top three MI were in other areas than the four for which I had developed DI lessons. Figure 1 displays each student's MI profile for their top three of the four profiled, Kinesthetic, Linguistic, Spatial, and Math/Logical.

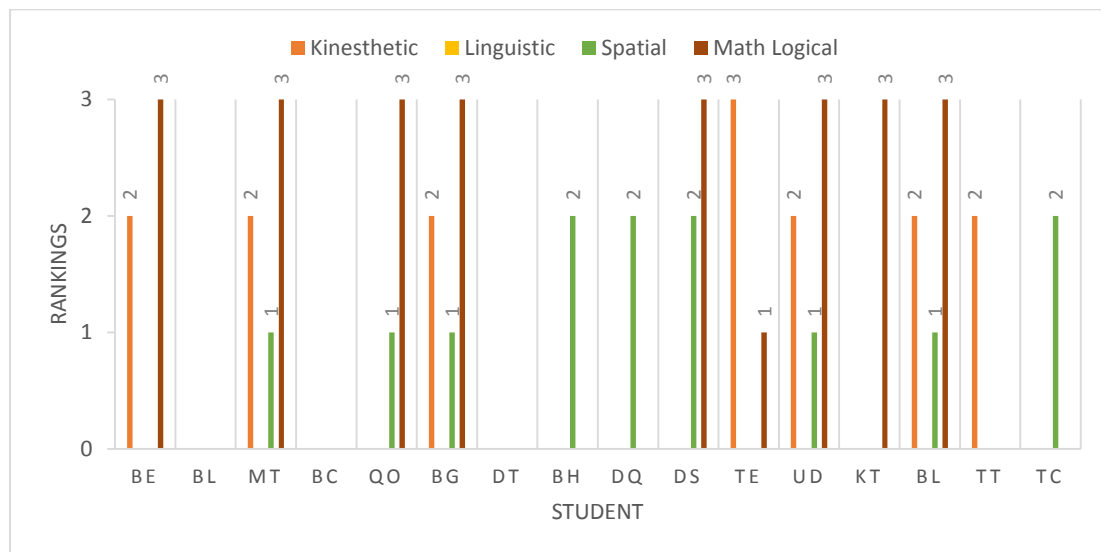

Figure 1. Multiple Intelligences profiles of students based on the highest three intelligences out of the four reviewed. The data are displayed with rankings of 1- 3. The highest scoring intelligence is identified as three, the second as two, and the third as one for all students. Student's pseudonym initials are used in lieu of actual names and initials.

The effects of MI on student understanding of concepts were analyzed based on pre and postunit assessments, pre and postunit student concept interviews, and pre and posttreatment student surveys. The results were grouped by high, medium and low-achievement levels. The assessment and concept interview scores were compared between nontreatment and treatment units. The percent change was calculated based on their scores and the normalized gain was used to verify those results. Table 2 shows class assessment average results.

Table 2
Nontreatment vs Treatment Results of Average Pre and Postunit Assessment Scores of All, High, Medium, and Low Groups with Percent Change and Normalized Gain

| Nontreatment Unit | | | | |
|---------------------------|---------------------------|----------------|------------------|---------------|
| Average Assessment Scores | Student Achievement Level | | | |
| | All ($N=15$) | High ($n=4$) | Medium ($n=5$) | Low ($n=6$) |
| Preunit | 0.4 | 0.6 | 0.5 | 0.3 |
| Postunit | 3.5 | 4.9 | 3.1 | 2.6 |
| % Change | 707.7 | 716.7 | 525.0 | 933.3 |
| Normalized Gain | 0.321 | 0.470 | 0.267 | 0.226 |

Treatment Unit 1

| | Average Assessment Scores | | Student Achievement Level | |
|-----------------|---------------------------|---------------------|---------------------------|--------------------|
| | All (<i>N</i> =16) | High (<i>n</i> =5) | Medium (<i>n</i> =5) | Low (<i>n</i> =6) |
| Preunit | 1.3 | 1.4 | 1.0 | 1.3 |
| Postunit | 2.4 | 2.2 | 2.8 | 2.3 |
| % Change | 89.5 | 57.1 | 175.0 | 75.0 |
| Normalized Gain | 0.168 | 0.108 | 0.250 | 0.171 |

| Treatment Unit 2 | | | | |
|------------------|---------------------------|---------------------|---------------------------|--------------------|
| | Average Assessment Scores | | Student Achievement Level | |
| | All (<i>N</i> =9) | High (<i>n</i> =3) | Medium (<i>n</i> =2) | Low (<i>n</i> =5) |
| Preunit | 0.6 | 1.0 | 1.0 | 0.6 |
| Postunit | 4.6 | 6.3 | 3.5 | 4.0 |
| % Change | 666.7 | 533.3 | 250.4 | 566.7 |
| Normalized Gain | 0.426 | 0.633 | 0.328 | 0.333 |

Treatment unit 1 showed the medium and low-achieving students had higher scores compared to the high-achieving students but overall the assessment scores were decreased compared to the nontreatment unit. Treatment unit 2 had increased normalized gains for all achievement levels in assessed understanding as compared to the nontreatment unit and the treatment unit 1. The nontreatment and treatment unit 2 had scaffold material from the previous semester that may have accounted for these increased gains. Treatment unit 1 was a new topic and, therefore, more difficult to grasp as well as a new way to learn. Table 3 displays the results for the concept maps.

Table 3
Nontreatment vs Treatment Results of Pre and Postunit Concept Map Interviews of All, High, Medium, and Low Groups with Percent Change and Normalized Gain

| Nontreatment Unit | | | | |
|----------------------------|---------------------------|----------------|------------------|---------------|
| Average Concept Map Scores | Student Achievement Level | | | |
| | All ($N=15$) | High ($n=5$) | Medium ($n=4$) | Low ($n=6$) |
| Preunit | 5.3 | 5.8 | 4.0 | 5.8 |
| Postunit | 21.6 | 26.4 | 12.8 | 23.5 |
| % Change | 305.0 | 355.2 | 218.8 | 302.9 |
| Normalized Gain | 0.315 | 0.402 | 0.165 | 0.345 |
| Treatment Unit 1 | | | | |
| Average Concept Map Scores | Student Achievement Level | | | |
| | All ($N=16$) | High ($n=5$) | Medium ($n=5$) | Low ($n=6$) |
| Preunit | 6.4 | 6.0 | 5.2 | 7.3 |
| Postunit | 15.1 | 14.0 | 14.4 | 18.7 |
| % Change | 136.5 | 133.3 | 176.9 | 154.5 |
| Normalized Gain | 0.202 | 0.167 | 0.189 | 0.243 |
| Treatment Unit 2 | | | | |
| Average Concept Map Scores | Student Achievement Level | | | |
| | All ($N=9$) | High ($n=3$) | Medium ($n=2$) | Low ($n=5$) |

| | | | | |
|-----------------|-------|-------|-------|-------|
| Preunit | 3.3 | 3.7 | 1.5 | 3.8 |
| Postunit | 9.0 | 13.7 | 2.5 | 8.8 |
| % Change | 172.7 | 272.7 | 66.7 | 131.6 |
| Normalized Gain | 0.081 | 0.142 | 0.014 | 0.071 |

The concept map interviews show the scores are decreasing for each successive unit. Again in treatment unit 1, the medium and low-achieving students had larger gains in comparison to the high-achieving students. Treatment unit 2 showed the largest increase in gains for the high-achieving students group alone. The students are showing positive increases in knowledge for each unit from their assessment scores but they are not making larger improvements in their understanding based on the same units with concept maps. The crosslinking of concepts is not clear in their concept maps and resulted in low percent change in pre and postunit scores, which may indicate that the treatment did not help students to increase their depth of understanding. Figure 2 displays data from student surveys based on confidence.

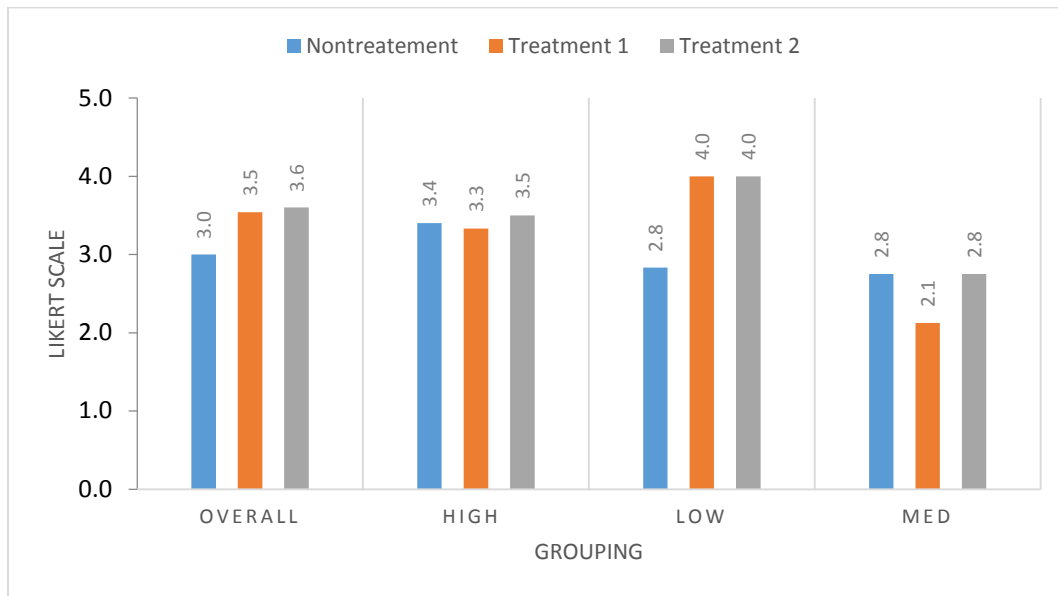

Figure 2. Average Confidence in Understanding Based on Student Survey for Different Achievement Levels, (Nontreatment $n=15$, Treatment unit 1 $n=16$, Treatment unit 2 $n=9$). Note. Likert scale 1= Strongly Disagree, 5= Strongly Agree.

Survey results indicated that students' overall confidence in their understanding of the material increased with each unit of treatment. The student survey questions were based on the students' confidence in understanding and perceived ability to take a quiz on the given material. There was an increase in their confidence levels, between treatment unit 1 and treatment unit 2 with an increase in normalized gain also. Low-level students showed the most gains in both treatments. During the interviews the low-level students requested that extra study time be included to help the foundation for their understanding. The medium-level students showed the lowest change in confidence. High-level students had little change.

Comparing all the data, the overall results showed: the assessments had an increase in normalized gain for the treatment unit 2, no increase in the concept mapping, and increases in confidence and ability to understand in both treatment units. The low-

achieving students had the greatest gains in confidence. Overall, the results are mixed and more study is needed to gain clarity of these results.

The low- level students were more confident in their abilities but not understanding. This group increased their scores and their engagement during class. According to interview and survey comments, these students were more actively pursuing opportunities to interact with other students and myself to gain knowledge. They attended extended learning programming and were eager to clarify earlier concepts. One student noted that she found “collaborating with groups” was helpful and two others stated “labs with discussion” were also helpful. Their group results had the most noticeable gains and increased momentum to learn for the remainder of the semester.

The effects of using MI guided DI on long-term memory were analyzed using post and delayed; assessments, surveys, and interviews. Table 4 displays these data for the delayed assessments.

Table 4
Average Postunit and Delayed Unit Assessment Scores, Percent Change and Normalized Gain for Various Achievement Levels

| Nontreatment Unit | Assessment Scores | | | | |
|-------------------|-------------------|--------|----------|----------------------|-----------------------|
| | Post* | Delay* | % Change | Normalized Gain Post | Normalized Gain Delay |
| All (N=8) | 3.5 | 4.1 | 18.4 | 32.1 | 9.9 |
| High (n=3) | 4.9 | 6 | 22.4 | 47 | 21.6 |
| Middle (n=3) | 3.1 | 3.3 | 6.7 | 26.7 | 3 |
| Low (n=2) | 2.6 | 2.5 | -3.2 | 22.6 | -1.1 |

| Treatment Unit 1 | | Assessment Scores | | | |
|------------------|-------|-------------------|----------|----------------------|-----------------------|
| | Post* | Delay* | % Change | Normalized Gain Post | Normalized Gain Delay |
| All (N=10) | 2.4 | 3.6 | 51.6 | 16.8 | 16.1 |
| High (n=3) | 2.2 | 3.7 | 66.7 | 10.8 | 18.8 |
| Middle (n=4) | 2.6 | 4 | 53.8 | 25 | 18.9 |
| Low (n=3) | 2.3 | 3 | 28.6 | 17.1 | 8.7 |
| Treatment Unit 2 | | Assessment Scores | | | |
| | Post* | Delay* | % Change | Normalized Gain Post | Normalized Gain Delay |
| All (N=9) | 4.6 | 4.1 | -10.6 | 42.6 | -9.1 |
| High (n=4) | 6.3 | 3.8 | -40.8 | 63.3 | -70.5 |
| Middle (n=1) | 3.5 | 7 | 100 | 32.8 | 53.8 |
| Low (n=4) | 4 | 3.8 | -6.3 | 33.3 | -4.2 |

Note. *Postunit and delayed unit assessment scores, maximum raw score is 10.

There was a marked improvement in treatment unit 1, as compared to treatment unit 2. Treatment unit 1 showed increase gains as compared to nontreatment of; 6% overall and 16% and 10% for medium and low subgroups respectively of normalized gains of delayed results. Treatment unit 2 showed improvement for only the medium group, which contained only one student. This data with their survey results shows conflicting results for student remembering and understanding. Figure 3 below displays the results for delayed student understanding of the treatment concepts.

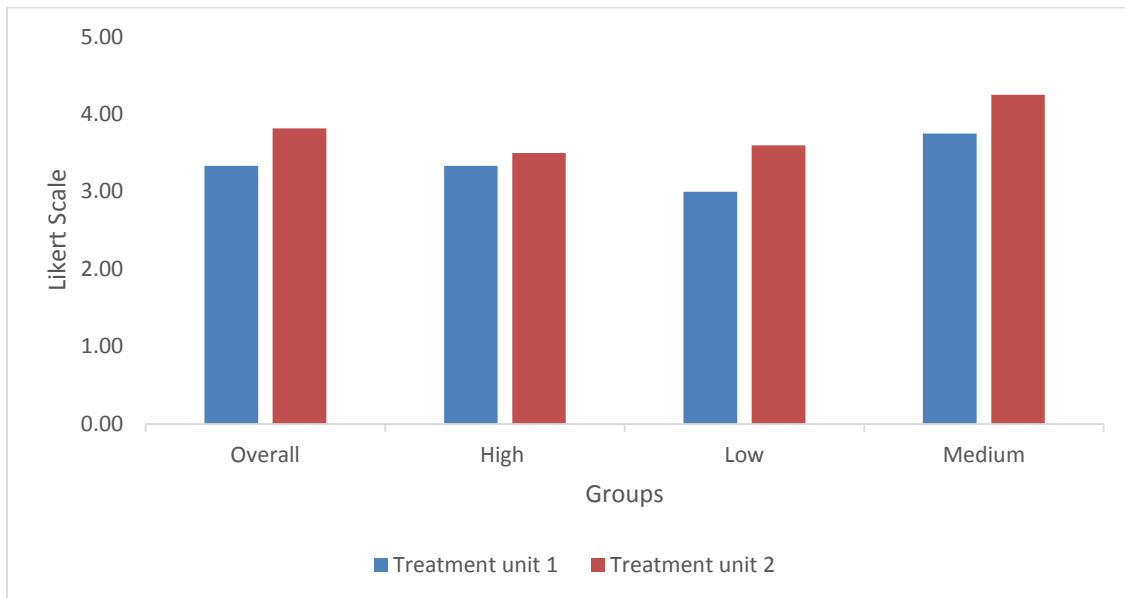

Figure 3. Delayed Survey Results Comparing Remembering for Treatment Unit 1 and Treatment Unit 2 Comparing All and Achievement Level Subgroups. (Treatment One; All $N= 12$, High $n=3$, Low $n=5$, Medium $n=4$. Treatment Two; All $N= 11$, High $n=2$, Low $n=5$, Medium $n=4$.) *Note.* Likert Scale 5 = Strongly Agree and 1= Strongly Disagree.

All results were higher for remembering in treatment unit 2. The medium achievement group data showed the highest confidence in their abilities to remember the information in the lesson. This was also reflected in their assessment results when comparing nontreatment to treatment gains between post and delayed normalized gain increases. Figure 4 displays the results for the students understanding of the lesson.

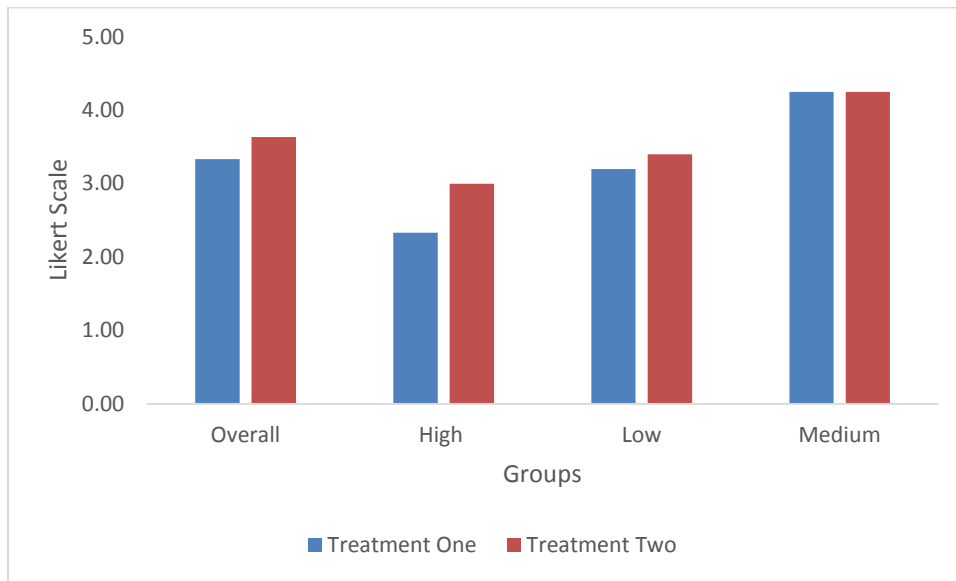

Figure 4. Delayed Survey Results Comparing Confidence in Understanding for Treatment Unit 1 and Treatment Unit 2 Comparing All and Achievement Level Subgroups. (Treatment unit 1; All $N=12$, High $n=3$, Low $n=5$, Medium $n=4$. Treatment unit 2; All $N=11$, High $n=2$, Low $n=5$, Medium $n=4$.) *Note.* Likert Scale 5 = Strongly Agree and 1 = Strongly Disagree.

The results for understanding indicate a higher confidence in treatment unit 2. The medium group results were the strongest in their confidence in understanding following the treatment as compared to the other groups.

The delayed results indicated the assessment results increased in all groups with treatment unit 1 as compared to the nontreatment results. Treatment unit 2 showed decreased retention in all groups except the medium group, which showed positive results. The medium group had the biggest gains with a three percent normalized gain for nontreatment results and a 19% and 54% normalized gain improved assessment results for treatment unit 1 and treatment unit 2 respectively. The medium group's survey data

also supported their results on ability to remember the material and MI grouping helped with their retention, as compared to the other groups. They also scored highest in their confidence in understanding and ability to take a quiz on the material. This groups interview details revealed that students were actively interacting with their partners and small group teaching for learning. They also stated they enjoyed the visual representations which appealed to their MI and their MI based on DI groups helped solidify their understanding of some topics in both treatments.

The results on engagement were triangulated through student surveys, student interviews and instructor observations. Figure 5 displayed the engagement question results from the surveys for the nontreatment and treatment units.

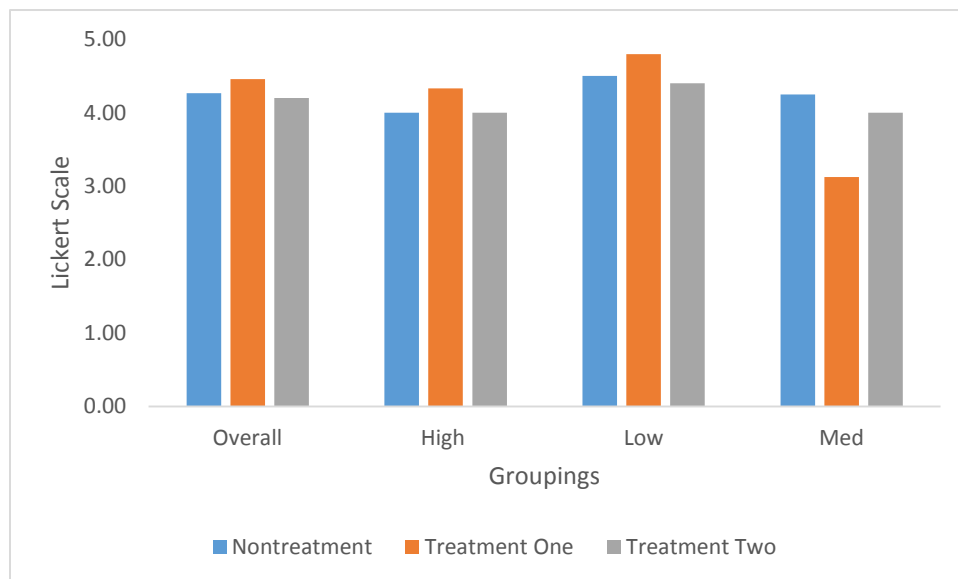

Figure 5. Level of Engagement Based on Enjoyment of Students by All and Achievement Level Subgroups Using a Likert Scale. (Nontreatment; All $N= 15$, High $n=5$, Medium $n=6$, Low $n=4$, Treatment unit 1; All $N= 12$, High $n=3$, Low $n=5$, Medium $n=4$. Treatment unit 2; All $N= 11$, High $n=2$, Low $n=5$, Medium $n=4$.) *Note.* Likert scale 1= Strongly Disagree, 5= Strongly Agree.

The results indicate that the high and low- level groups enjoyed treatment unit 1 over treatment unit 2 and both treatment units over the nontreatment unit. The medium grouped showed a decrease in both treatments from the nontreatment but an increase in treatment unit 2 over treatment unit 1. Figure 6 displays the results based on interview data for peer engagement from interviews.

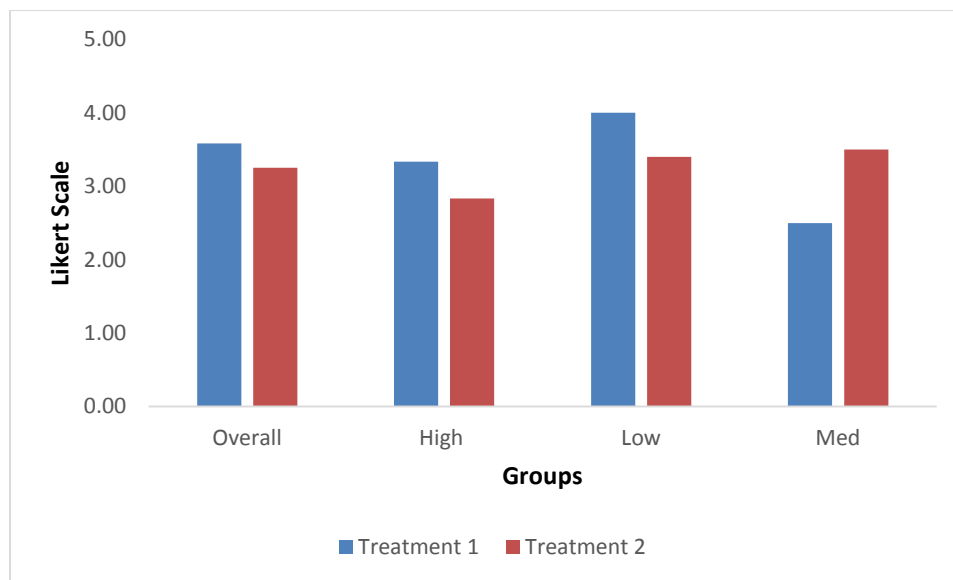

Figure 6. Level of Engagement Based on Perception of Peer Engagement by All and Achievement Level Subgroups Using a Likert Scale. (Nontreatment; All $N= 15$, High $n=5$, Medium $n=6$, Low $n=4$, Treatment unit 1; All $N= 12$, High $n=3$, Low $n=5$, Medium $n=4$. Treatment unit2; All $N= 11$, High $n=2$, Low $n=5$, Medium $n=4$.)

Note. Likert scale 1= Strongly Disagree, 5= Strongly Agree.

The peer engagement interview question is based upon the interaction of students in their new groupings, homogeneous and heterogeneous. The low-level students experienced the highest engagement overall compared to the class results. These students had experienced engagement with their peers at a higher level for treatment unit 1 as compared to treatment unit 2. These results were the same for the high level students. The

medium level students actually felt an increase in engagement with treatment unit 2.

Figure 7 displays the results of anticipating the next classroom experience.

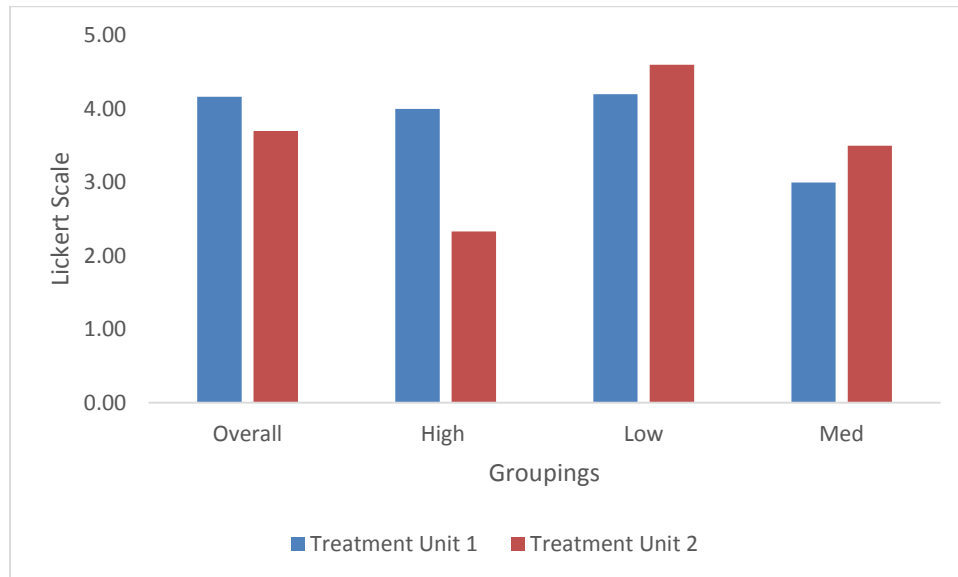

Figure 7. Level of Engagement based on Anticipation of Upcoming Labs and Activities in Class by All and Achievement Level Subgroups Using a Likert Scale. (Nontreatment; All $N=15$, High $n=5$, Medium $n=6$, Low $n=4$, Treatment unit 1; All $N=12$, High $n=3$, Low $n=5$, Medium $n=4$. Treatment unit 2; All $N=11$, High $n=2$, Low $n=5$, Medium $n=4$.) Note. Likert scale 1= Strongly Disagree, 5= Strongly Agree.

The high-level students were looking forward to the next treatment unit after completing treatment unit 1 but the level of excitement dramatically decreased after treatment unit 2. The medium and low-level groups were more excited after both treatment units to the next lesson. The low-level students were the most eager and enthusiastic group in the treatments. The data from the interviews about group placement with multiple intelligences was the same. The high-level students were not as convinced by the second treatment that they were in a good group. The low and medium-level

students felt stronger about their placement in their groups with each successive treatment unit.

The survey data alone did not show an increase in engagement in the overall and group evaluation between nontreatment and treatment units. However, treatment unit 1 did show an increase in enjoyment overall and for high and low-level subgroups. The survey data with the interview data, indicated a general trend of engagement through increased enjoyment of labs and activities in both treatments, especially for the low-level subgroup. There was also a marked agreement in all subgroups that the MI grouping helped their learning ability. The high and low-level subgroups were more engaged in the treatment unit 1 compared to the medium-level subgroup. The low and medium-level groups were more engaged in the treatment unit 2.

Teacher self-perception was analyzed using teacher journal prompts, teacher surveys and colleague observations. Most of these results are qualitative. Quantitative results from teacher prompts and survey are shown in figure 8 below.

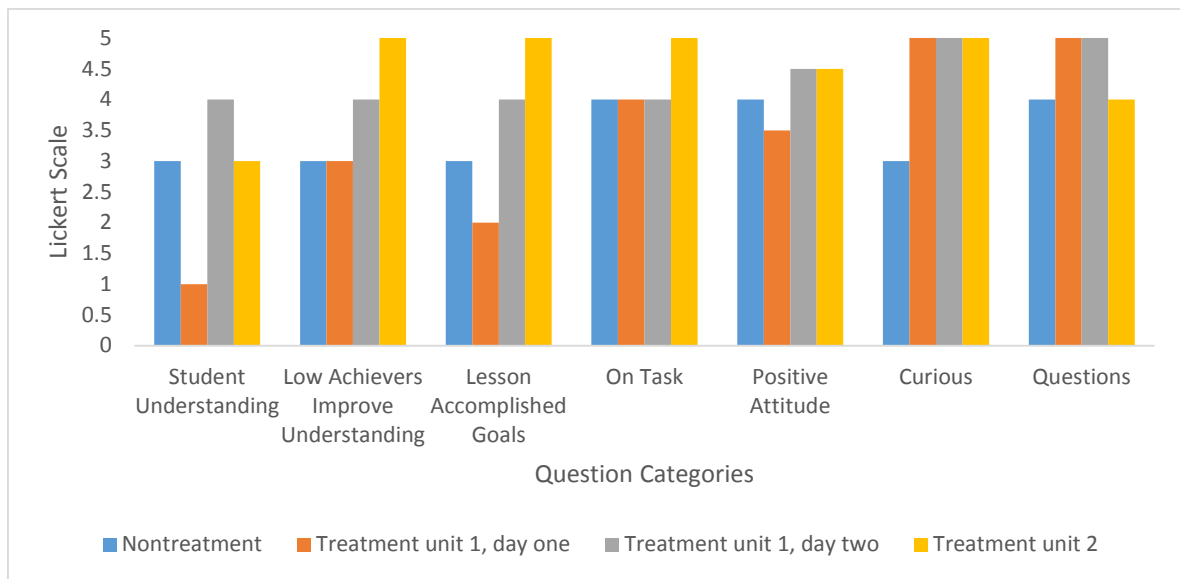

Figure 8. Teacher Survey and Journal Prompt Questions about Treatments Using an Average Likert Scale. *Note.* Likert scale 1= strongly disagree, 5= strongly agree, ($N=1$).

There were marked improvements in the types of class interactions from the nontreatment to the treatment units. I noticed different interactions among students and their curiosity was increased due to the structure of the activities. The students were eager to work together and posed questions about the unit to each other and to me. There was also marked improvement in low-level achievement students and their study patterns. One low-level student had six pages of notes before we started treatment unit 2. The interaction among students was directed at the learning task on hand. I noticed students solidified their understanding between the first and second day of the unit due to its structure of homogeneous to heterogeneous grouping. The teacher observations confirmed these results with their observations. The observer made one note of student questions during lab of “what would happen if...?” and during class “what

happens to...?” There was also observations of “genuine reactions to experiments” and “that makes sense now!”

For deeper analysis, I reviewed the assessment and survey data based on multiple intelligence groupings, kinesthetic versus spatial. Figure 9 display those results.

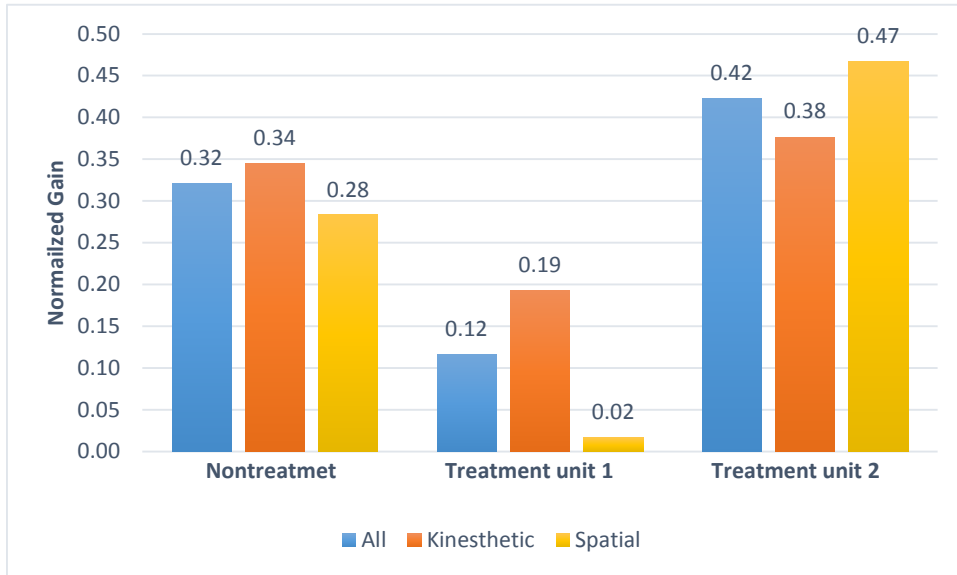

Figure 9. Multiple Intelligence Grouped Normalized Gain of Assessment Scores. (1. Nontreatment $N=15$, 2. Treatment unit 1 $N=16$, 3. Treatment unit 2 $N=14$)

These results indicated an increased gain in treatment unit 2 versus treatment unit 1. This was expected due to the use of treatments being new to students. It was also noted treatment unit 1 had increased gains in the kinesthetic groupings and treatment unit 2 had increased gains in the spatial treatment. Figure 10 reveals the student survey results for the first treatment.

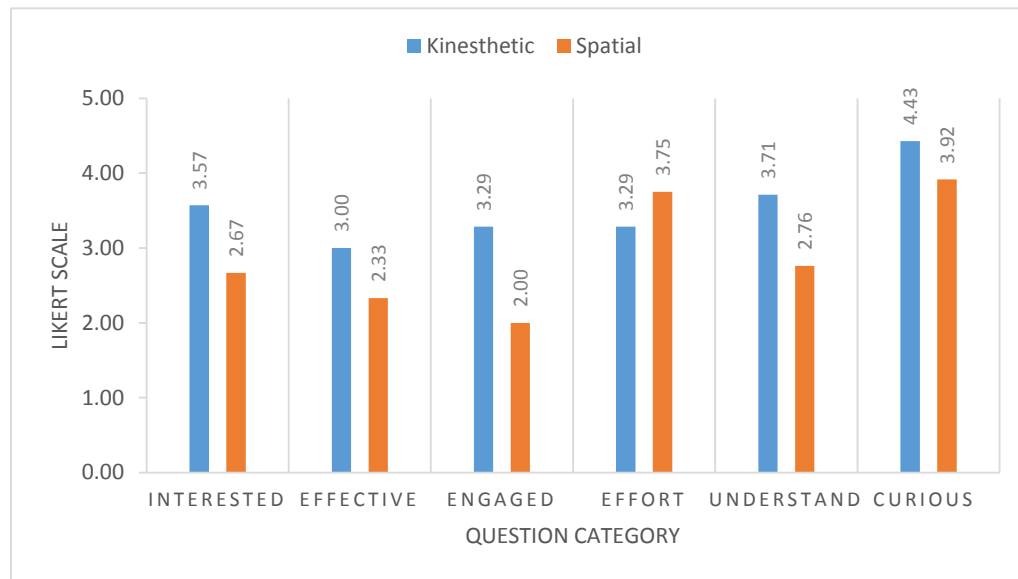

Figure 10. Treatment Unit 1 Multiple Intelligence Grouped Student Survey Questions about Class Using a Likert Scale. (Kinesthetic $N=9$, Spatial $N=7$). *Note.* Likert scale 1= Strongly Disagree, 5= Strongly Agree.

Treatment unit 1 shows results favoring the kinesthetic learners over the spatial learners. The kinesthetic group showing positive results in all areas and less effort in their processing of information. These results further indicate the kinesthetic groups had to put in more effort and were less curious and interested in treatment unit 2. The kinesthetic survey results are in figure 11.

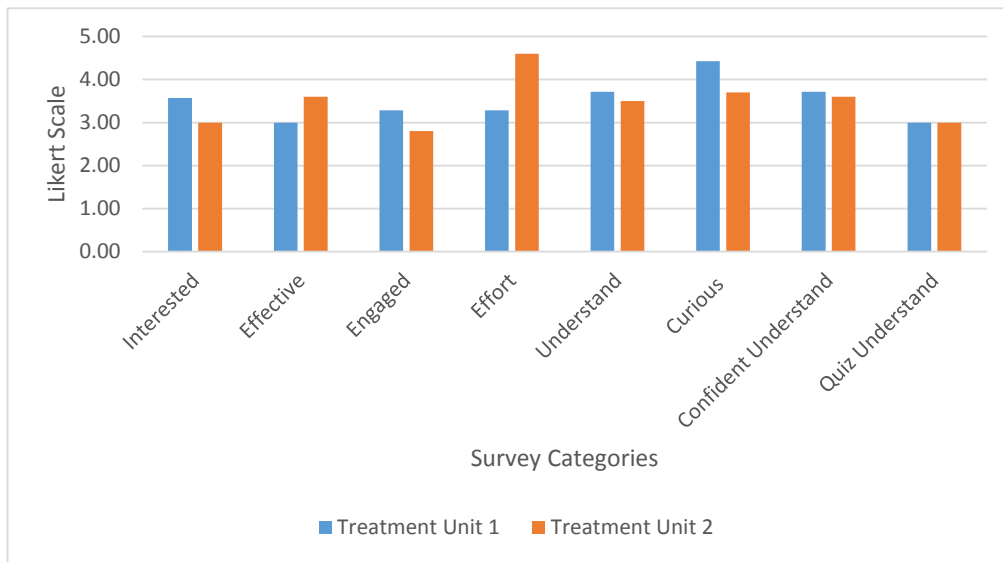

Figure 11. Kinesthetic group student survey questions concerning treatments using average Likert scale. ($N=9$)

Note. Likert scale 1= strongly disagree, 5= strongly agree.

Figure 12 depicts the results from the spatial group's survey results.

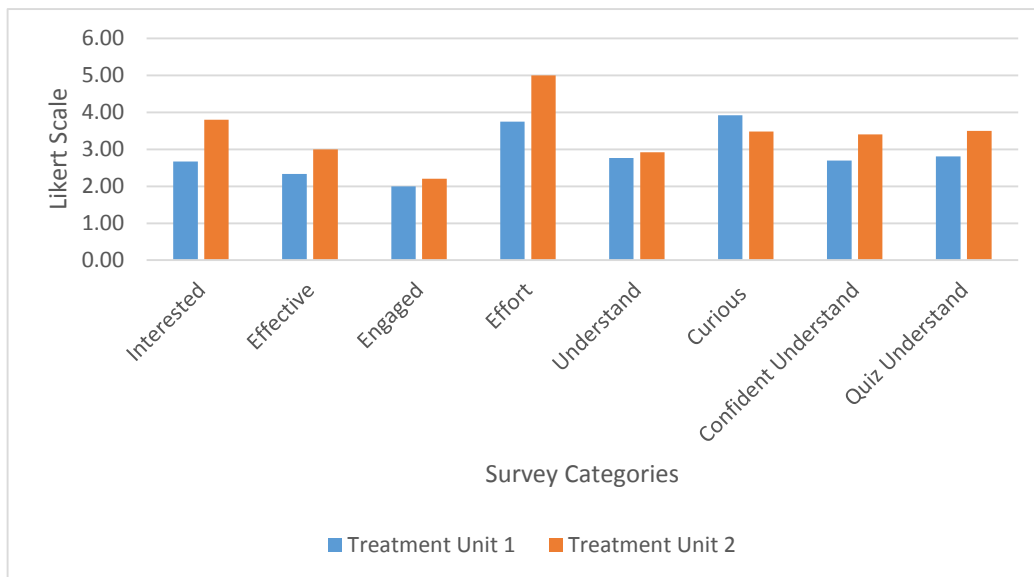

Figure 12. Spatial Group Student Survey Questions Concerning Treatments Using Average Likert Scale. ($N=7$). *Note.* Likert Scale 1= Strongly Disagree, 5= Strongly Agree.

The spatial group survey results indicate these students were more engaged and interested overall in treatment unit 2. They were putting in more effort but this could be a result of trying to achieve results rather than overcoming issues with the lesson design.

There were decreased scores, engagement, and understanding in treatment unit 1 as compared to treatment unit 2 and treatment unit 2 had marked improvement in scores and effort for the spatial students. There was also a noticeable difference in the student's reception to the lessons, with kinesthetic learners showing higher scores in survey results over spatial in treatment unit 1. Treatment unit 2 showed more level results between the kinesthetic and spatial groups. Treatment unit 2 teacher observations also confirmed this with my notes on members actively participating, all spatial groups were "yes" and all kinesthetic groups were "no".

INTERPRETATION AND CONCLUSION

The goal of this project was to determine the effects of using MI- guided differentiated activities on student understanding. Before the project began there were issues with students not having a high intelligence in the areas of treatment design, therefore, I was forced to place the students into areas of their weakest intelligences and examine the results. The assessments showed an increase in normalized gain scores for treatment unit 2 but not treatment unit 1. Treatment unit 1 had no scaffold material from previous units. This was also the first treatment unit with the new activity structure. By the implementation of treatment unit 2 the students were better acquainted with their groupings and more comfortable interacting with each other. The assessment results correlated with the survey results on understanding with treatment unit 2 scores being greater than treatment unit 1. The treatments revealed the students enjoyed

interactions with each other, and their desire to gain more knowledge. This was most noticeable to me by the way the students phrased their questions to clarify their understandings.

The most satisfying results were obtained from the low- level achievers. Their assessment scores showed continuous improvements in each successive treatment. Their confidence and engagement were dramatically increased with their MI groupings and this is evident in their survey results. The interviews with these students revealed a renewed interest in trying to gain knowledge in weak areas from the beginning of the semester as well as an increase in their study time and preparation. I grouped all the low achievers with high achievers in their homogeneous grouping. I was hoping to solidify the knowledge of the high and bring up the content knowledge of the low. The results indicate a renewed vigor for the low achieving students and gave them confidence throughout the rest of the semester to keep up efforts to do well on the exam.

In examining the results on long-term memory, there were positive results in treatment unit 1 versus treatment unit 2. Treatment unit 1 showed tremendous gains over the nontreatment as well. Treatment unit 2 was only very successful for the medium achievement group students, which contained only one student. Treatment unit 2 showed delayed survey results of increased improvement in all categories including; remembering, MI grouping helpfulness, confidence in understanding and quizzing. Although the delayed assessment results do not connect with the survey results, the delayed student interviews reveal the students were more confident and were putting in more effort due to the new lesson structures.

The engagement results show through all surveys, interviews and colleague observations, that students were genuinely refreshed to the subject and study habits during and after the treatment units. This engagement was evident in the dramatic increase in enjoyment results from the survey data and supported by interview questions about “looking forward to labs and activities” and “MI grouping helped me learn.” I also started to think a little deeper about these groups and whether it was a design in the grouping, high and low, or the MI that was helping. There were some fluctuations in the achievement group’s results. I also noted that two of my students were not improving in their engagement as I had hoped for. These two students were enjoying the new structure but their partners were being distracted by them. I went back and correlated my data by MI groups to see if I could notice any changes in engagement. The gains were higher in the kinesthetic group for treatment unit 1 and higher for the spatial groups for treatment unit 2, as compared to fairly close for the nontreatment. I may have prepared better labs and activities for one group versus the other in each treatment unit.

Effects on teacher self-perception were fairly unchanged on Likert scale data but qualitative notes showed evidence that I was excited and pleased. The low-level student engagement increase was evident even before the data were tabulated. One student in particular came in with six pages of notes before we even started treatment unit 2. Their involvement as they grew to realize they were counting on each other to gain insight showed a deeper interest in figuring things out. The engagement was also very positive to watch, as most times I was simply observing what I had put into motion. I was definitely looking forward to observing how my students interacted with the new methods. The first day of treatment unit 1 was awful. I thought the whole design process was a fail.

The kinesthetic grouped students couldn't get equipment to work and the spatial groups had no idea what they were doing due to their lack of preparation. Then the glorious second day of treatment arrived and the "ding" moments happened. I was truly enthralled as I watched the mixed, heterogeneous groups work together to explain using their new MI based knowledge, what they were observing or why it was happening. I am unhappy with my ability to design spatial unit lessons to the same level as kinesthetic lessons. From the survey results based on MI groupings, I am convinced one or the other intelligence group gets a good entry lesson and through correlation everyone solidifies their knowledge.

Overall, the design of the treatment was positive with some areas or groups reaping more benefits than others. That is to be expected with differentiated instruction because of the grouping strategies inherently involved in the design. I would like to make improvements to the lesson designs and possible grouping changes. I would dig deeper into the lesson design to ensure high engagement for each MI in the classroom. I would also like to rearrange groups to better integrate the medium students into the homogeneous groups; the heterogeneous groups were well mixed. I also would like to try to generate small surveys between homogeneous grouping and heterogeneous grouping. There may be a notable difference in between these exchanges in group activities.

VALUE

The use of differentiated instruction is a valuable tool in any teacher's toolbox of classroom instruction. Incorporating this technique gives groups of students individual ownership of their learning due to lessons designed for them. The incorporation of differentiation helps break up classroom monotony and develops higher cognitive

skills through student interactions. By blending DI with MI, a teacher has tailored a lesson even further to a particular audience. Reengaging students by homing in on their highest intelligence area and easing of the process of learning. This design also allows the ability of everyone to be classified as smart without using an IQ test.

The study shows that students want to be engaged during class. The techniques I have been using for AP Chemistry class are not engaging enough and I need to modify my teaching to better fit the 5E model I use in my other classes. Students also need to understand the repercussions of their commitment to their learning and the value this brings to the classroom. This project can be modeled in other classrooms to better engage students and boost the confidence of low achievers. My school has poor reading and writing scores, therefore, a high level of low achievers in these areas when compared to other schools in the district. In order to boost the low-achieving students self-reliance and overcome these hurdles, simply asking them what they, as student, can do and I, as a teacher, can do to improve performance shows the commitment to the relationship. The next steps are to find ways to engage and plan lessons for students outside the four MI my project focused on. These changes may be small, but could help influence positive learning.

This project revealed a lack of a very valuable MI profile to AP Chemistry. All of my students are not high mathematical/logical learners. I had taken this MI profile for granted. This treatment design is an opportunity to modify instruction to be able to assist the students without high mathematical/logical intelligence and are going to struggle. This change is most likely due to our student body changing from predominately engineering students to a mix with biotechnology students. These students are more

nature oriented and very good at memorizing. I will need to help them critically analyze information and increase their math skill level. They are definitely going to need these skills as they transition from high school to college because biotechnology programs generally require three years of chemistry courses. I am going to play a very influential role in helping these students be prepared for their college careers.

This style of instruction can be used in any classroom. The lesson design and class need to be examined for different presentations and activities as well as student MI profiles. This lesson design could really be beneficial for the areas of learning that are considered rote. The class can be used to engage students in a learning frame of mind within an environment that is not of interest for the student. This can also be incorporated in group projects where the assignment of project pieces are carefully aligned with a student's highest intelligence. The same technique of grouping would be designed in a corporation where individuals are brought on because of their expertise but consideration is given as to how the individual will fit into the team as well.

I would like to incorporate this project into my other classes. Starting at the smallest level by arranging seating groups by MI profile, homogeneous partners and heterogeneous groups of four students. This could be done for activities or labs only or entire classroom seating structures. The largest area for project expansion would be to examine results not from just pre and post and high, medium and low achievement groupings but from the MI profile as well. The results are complex and breaking groups out by a more fastidious design initially would ease in their analysis. These deeper analyses may provide greater teacher reflection and improve lesson design.

I would like to be able to design lessons that would attend to each students' higher MI profiles, even when they are not part of the general profiles most lessons are catered to.

I learned that my MI profile was comparable to most of my high-level achieving students. I interpreted that as an ease for understanding concepts in chemistry because of labs, spatial presentation of data and logic of making these pieces, concepts and their representation, fit together. Upon reflection of when I attended college, and my ability to grasp chemistry so easily can be connected to my MI profile. My profile illustrates my thinking follows logical and mathematical patterns. My eagerness to share how a mathematical equation supports a chemical concept is geared to my ease in processing information this way. This has led to my reflection of student understanding in each classroom. If a student struggles, I now review the student's MI profile and how I can illustrate a concept to ensure they grasp it. Some of my biggest challenges are teaching students that have a very low logical intelligence because it is not obvious to them why a problem is worked in a certain order. I have to give them the information and let them think or talk their way through a problem. Sometimes it takes some deep reflection and time to process before the concept is clear. This student profile of low logical intelligence has enhanced my teaching skill set to present information in different ways or through peer assistance. The students, as well as myself, should reflect on our MI profiles to understand how we learn and teach.

REFERENCES CITED

- Algozzine, B. & Anderson, K.M. (2007). Tips for teaching: Differentiating instruction to include all students, preventing school failure. *Alternative Education for Children and Youth*, 51(3), 49-54.
- Armstrong, T. (2013). Assessment: Find your strengths! Retrieved from <http://www.literacyworks.org/mi/assessment/findyourstrengths.html>
- Berman, M. (2011-08-01). Multiple intelligences theory revisited. *Humanising Language Teaching*, 13(4). Retrieved from <http://www.hltmag.co.uk/aug11/sart.htm>
- Brown-Wright, G. A. (2004). *Effects of using presentation formats that accommodate the learner's multiple intelligences on the learning of freshman college chemistry concepts*. (Doctoral dissertation, The University of Texas at Austin). Retrieved from <http://search.proquest.com/docview/305126197?accountid=28148>. (305126197).
- Bunce, D., VandenPlas, J., & Soulis, C. (2011). Decay of student knowledge in chemistry. *Journal of Chemical Education*, 88(9), 1231–1237.
- File:Galvanic Cell.svg. (2014). - Wikimedia Commons. Retrieved from http://commons.wikimedia.org/wiki/File:Galvanic_Cell.svg
- Gardner, H. (1983). *Frames of mind: The theory of multiple intelligences*. New York: BasicBooks,
- Gardner, H. (Director) (2011). *The theory of multiple intelligences: As psychology, as education, as social science* [Web]. Retrieved from <http://howardgardner01.files.wordpress.com/2012/06/473-madrid-oct-22-2011.pdf>
- Gregory, G., and Herndon, L. E. (2010). *Differentiated instructional strategies for the block schedule*. Thousand Oaks, California: Corwin.
- Iflazoglu Saban, A. I. (2011). An evaluation of the teaching activities implemented in the elementary science and technology courses in terms of multiple intelligence theory: A sample from adana. *Educational Sciences: Theory and Practice*, 11(3), 1641-1649.
- Kelly, Matthew (2009) *AP Chem Solutions Teacher's Resource Package*. Retrieved from <http://www.apchemsolutions.com/>
- Lab 10:redox reactions*. (2007). Unpublished manuscript, Chemistry Department, Michigan State University, Angel, MI, Retrieved from <https://www.msu.edu/course/lbs/1721/Lab10-S06-Electrochemistry.pdf>

- Llewellyn, Douglas (2011). *Differentiated Science Inquiry*. Thousand Oaks, California: Corwin.
- Mokhtar, I. M. (2008). Informational literacy education: Applications of mediated learning and multiple intelligences. *Library & Information Science Research*, 30(3), 195-206.
- Moore, J. (2010, January 1). Electrochemical Cells for AP Chemistry. Education.com. Retrieved from <http://www.education.com/study-help/article/electrochemical-cells/>
- Ordover, A. O. (2012). Teacher perceptions of differentiated instruction. (*Doctoral dissertation*), Retrieved from <http://search.proquest.com/docview/1146589662?accountid=28148>
- Rushton, G. T. R. (2012). Improving high school chemistry teaching via the “trickle up” effect: A perspective on the new Ap chemistry curriculum framework. *Journal of Chemical Education*, 89, 692–693.
- Suarez, E. I. S. (2002). Engaging students through the use of cooperative learning and multiple intelligences. (*Doctoral dissertation, Pacific Lutheran University*), Retrieved from <http://search.proquest.com/docview/230986000?accountid=28148>
- Waller, T. H. W. (2011). Advanced placement teachers' perceptions of differentiated instruction. (*Doctoral dissertation, Walden University*), Retrieved from <http://search.proquest.com/docview/916247772?accountid=28148>. (916247772)
- Wright, G. W. (2004). Effects of using presentation formats that accommodate the learner’s multiple intelligences on the learning of freshman college chemistry concepts. (*Doctoral dissertation, University of Texas*), Retrieved from <http://search.proquest.com/docview/305126197?accountid=28148>

APPENDICES

APPENDIX A
LESSON MATERIALS

Treatment LESSON PLAN
Day 1, MI Homo-grouping

Teacher: Elaine Gibbs

Subject(s): Electrochemistry

Grade(s): 10-12

Objectives: To introduce the concept of Electrochemical Cells

Materials Needed: Power Point set, Problem Set, Lab handout and Lab supplies

Brief Description: Electrochemistry is introduced through a lab and a Problem Set.

Students have been assigned PowerPoint notes review at home.

Lesson: Students are grouped in matching MI pairs based on their MI profiles. Spatial partners are given a copy of the PowerPoint and problems to work with. Kinesthetic partners are given a lab to complete.

Assessment: After lesson, students are asked to write using a prompt in their notebooks to reflect on knowledge gained during the day's lesson.

Source: APChem Solutions

Included are sample page PowerPoint, sample page problem questions and lab.

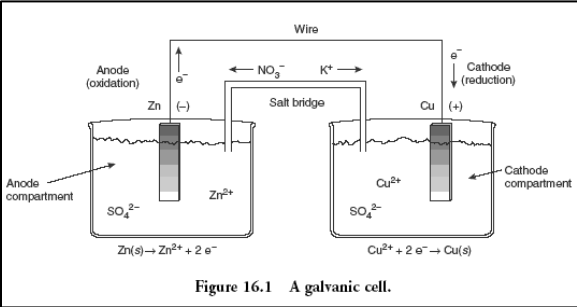
| <p style="text-align: center;">Voltaic (Galvanic) Cells</p> <ul style="list-style-type: none"> • A device that transfers electrons from one reactant to another through a pathway • As opposed to a direct transfer • Always spontaneous ($\Delta G < 0$) • Chemical energy is converted into electrical energy that moves electrons. | <p>The electrons were transferred directly in the previous example. Solid zinc gave two electrons to aqueous copper directly.</p> <p style="text-align: center;">In a voltaic cell the electrons travel through a wire.</p> |
|--|--|
| <p style="text-align: center;">Image from Electrochemical Cells in Ap Chemistry</p>  <p style="text-align: center;">Figure 16.1 A galvanic cell.</p> | <p>This is the same as the first reaction, only it is split into two $\frac{1}{2}$ cells. The voltaic cell forces the electrons to travel through a wire in order to complete the oxidation reduction process.</p> <p>Each half cell has a solid electrode immersed in an electrolytic solution (a solution containing ions). The anode is the electrode where the oxidation takes place (loses electrons). The cathode is the electrode where the reduction takes place (gains electrons).</p> <p><u>The reactions at each $\frac{1}{2}$ cell</u></p> <p>The zinc metal loses two electrons as a solid zinc atom becomes an aqueous Zn^{2+} ion. Those electrons travel through the anode, through the wire, and into the copper cathode. When the electrons arrive at the copper electrode Cu^{2+} ion in solution accepts them and turns it into a solid copper atom that plates itself to the cathode.</p> <p>As this reaction continues the mass of the anode decreases and the mass of the cathode increases.</p> <p><u>The salt bridge</u></p> <p>Originally, the oxidation $\frac{1}{2}$ cell is electrically neutral – having equal numbers of Zn^{2+} and SO_4^{2-} ions in the electrolytic solution. The reduction $\frac{1}{2}$ cell is also neutral- having equal numbers of Cu^{2+} and SO_4^{2-} ions in solution.</p> |

Lecture 21
Electrochemistry I
Worksheet

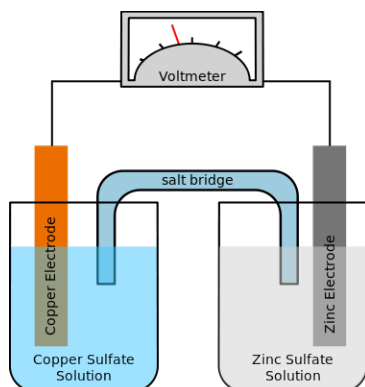

Image from Wikimedia Commons.com.

1. The following questions refer to the above diagram of a voltaic cell.
 - a. Write the balanced net ionic equation for the spontaneous redox reaction that occurs in the voltaic cell above.
 - b. Calculate the standard cell potential, E^0 , in volts for the spontaneous reaction that occurs in this cell.
 - c. What concentrations of Cu^{2+} and Zn^{2+} are necessary for the cell to produce the standard cell potential calculated in part b.
 - d. Which electrode is the anode, and which is the cathode in the cell above.
 - e. Would it be better to use NaCl or NaOH in the salt bridge? Explain.
 - f. In which direction are the electrons flowing?
2. A voltaic cell is constructed with Cr/Cr^{3+} at one half cell, and Cu/Cu^{2+} at the other. Both half cells are at standard conditions.
 - a. Write the half reaction that place at the anode.
 - b. At which electrode does the reduction occur?
 - c. Write the balanced net ionic equation for the spontaneous redox reaction that occurs in the voltaic cell.
 - d. Calculate the standard cell potential, E^0 , in volts for the spontaneous reaction that occurs in this cell.

e. Would it be better to use Na_2SO_4 or BaSO_4 in the salt bridge? Explain.

RedOx Reactions

Lab Modified from Michigan State University, Chemistry Department.

Laboratory Goals

In this laboratory, you will:

- develop a basic understanding of what electrochemical cells are
- develop familiarity with a few different examples of redox reactions
- develop hypotheses regarding changes to pennies

Introduction:

Oxidation-reduction reactions are second fundamental type of chemical reaction. Redox reactions as they are often called are simply reactions that involve the transfer of electrons from one chemical species to another. This electron transfer will obviously shift the ratio of the protons to electrons on the atoms involved and will thus affect the oxidation number of the atoms involved. Atoms that gain electrons are said to have been *reduced* (their oxidation number goes down) and atoms that have lost electrons are said to have been *oxidized*.

Redox chemistry is the basis of the field called electrochemistry. It should be easy to see why the name electrochemistry fits these reactions so well, as they always involve the transfer of electrons from one chemical species to another. One important consequence of electrochemical reactions occurs if you separate the oxidizing agent from the reducing agent, connecting them only with electrodes, a wire, and salt bridge you create an electrochemical cell. Doing so forces the electrons to travel through the wire from the reducing agent to the oxidizing agent and so creates an electrical current (the units of current are Amperes, or Coulombs/second). If a particular redox reaction is thermodynamically spontaneous, then the electrons will transfer spontaneously and a current will be produced. An electrochemical cell that generates a current is called a voltaic or galvanic cell. You are probably most familiar with these types of cells as batteries. If the reaction is not spontaneous, then an electrical current (i.e., electrons) are required to make the reaction proceed. An electrochemical cell that uses a current is called an electrolytic cell.

Let's look at the structure of an electrochemical cell a little more closely. The redox reaction we will use as an example is the reaction:



The copper here is being oxidized (and is therefore the reducing agent, meaning that it is causing something else to get reduced):

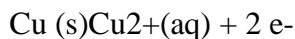

and silver ions are being reduced (making them the oxidizing agent, meaning that they are inducing another material to be oxidized):

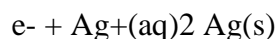

This reaction will happen spontaneously if we simply put the two materials together. However, if we were interested in trying to use this reaction to generate electricity, we would need to construct an electrochemical cell, which would require that we separate the copper from the silver ions. We would first make a $\text{Cu}|\text{Cu}^{2+}$ half-cell (the line indicates the copper and copper ions are in different phases) by placing a copper electrode (which is just metallic copper) in a solution of copper ions. We also need to construct an $\text{Ag}^+|\text{Ag}$ half-cell—in this case the metallic silver is used only as a means to convey electrons to the aqueous silver ions. Since the metallic silver is not important for the reaction to proceed, we can use any inert solid that is conductive—for the sake of this example we will use silver, but silver makes for a very expensive inert electrode! Once a wire is in place to connect the copper electrode to the silver electrode we only need a salt bridge to complete the circuit. Once the cell is fully connected, the copper electrode will be oxidized, electrons will spontaneously flow from the copper electrode to the silver electrode, and silver ions will be reduced to solid silver, which will be observed as solid silver plating out on the silver electrode. We call the electrode at which oxidation takes place (copper in this case) the anode and the electrode at which reduction takes place the cathode. Hence electrons in a galvanic cell always flow from the anode to the cathode. Since the anode is the “source” of electrons, it is conventionally given a negative sign while the cathode, being where the electrons are going to, is given a positive sign. Since electrons flow to the cathode, the cathode's half-cell will gain an overall negative charge from the excess of electrons (this is not to be confused with the conventional designation of the anode as “negative”). To balance this charge, negative ions in the cathode's half-cell will flow via the salt bridge into the anode's half-cell and positive ions in the anode's half-cell will flow into the cathode's half-cell—in this way the entire circuit is completed (see Figure 1).

Figure 1. A Typical Galvanic Cell

Electrolytic cells are similar, but since the redox reaction is not spontaneous electrons are made to flow against the direction they would normally go. Because of this the anode is conventionally given a positive sign and the cathode is given a negative sign (compare this to a galvanic cell). Electrons still flow from anode to cathode in an electrolytic cell.

There are many uses for this electrical energy which are of importance in everyday life, such as batteries. This week in lab you will examine a few different types of redox reactions, including making a series of electrochemical cells and performing a couple of small redox reactions.

Procedure

Work in partners for this lab. Note that you may do the sections in any order that you wish.

Part I-Making electrochemical cells

In this portion you will set up a series of different electrochemical cells and measure their voltage potential. For this portion of the lab, you will need to create a number of half cells. The half cells will consist of each a solid metal and some solution containing the metal cation. These half cells will be connected via the wire that you will attach. The electrons will flow through the wire from one half cell to the other. In order to actually get electrons to flow through the wire, we must have a complete circuit. To complete the circuit, we need what is called a salt bridge. This is an object that prevents the two half cells from coming in direct contact (and thus reacting without the electrons needing to go through the wire,) but also allows us to maintain electric neutrality.

The set-up for your electrochemical cells will be very simple. You will need to cut a piece of the 70 mm filter paper into a large X shape. Each arm of the X will be where you will build one of your electrochemical half cells. Wet one arm of your filter paper with a couple drops of the metal cation solution, then place a piece of the same solid metal on top of the now wet arm. Repeat on other arms with the other metals.

In the center of the X is where you will create the salt bridge. To do this, place a couple drops of sodium chloride solution right in the middle of X. Be sure that this wet spot reaches the wet portions of ALL the metal solutions. To test the voltage, you will need to place one arm of the voltage probes on each of the two metals you wish to test. Be sure to record the voltage differences between ALL of the different possible combinations. Keep in mind that there are more than 4 half cells to test. Can you think of any way to avoid having to create multiple different setups?

Questions:

1. What happens if you switch the voltage leads?

Testing the effect of solution concentration

In this part of the lab, you will create half cells in a slightly different fashion so that you can investigate the effect of concentration. Figure out what you are going to need to do below to be sure that you will be able to feasibly do the metals that you select.

Using the 12-well plates, fill 2 wells with solutions of different concentrations of a single metal salt. (You will need to actually make one of them.) Fill a 3rd and 4th well plate with another metal salt solution of two different concentrations. Place a piece of the same solid metal so that it is sticking up and out of the metal solution. Wet thin strips of either filter paper or the bibulous paper with the sodium chloride solution and use them as the salt bridge to connect the different half cells. Measure the different combinations of half cells.

Questions:

2. What do you notice about the voltages of the cells that differ only by the concentration?
3. What is the voltage difference between the two half cells of the same metal?

Part II-Playing with Pennies

Put 4 g of zinc in the bottom of a 100 mL beaker. Next, carefully pour 10-30 mL of 1 M NaOH in the beaker. Place the beaker on a hot plate and heat the solution to 80-90°C; if it is heated to boiling the zinc distribution will be disturbed. While the solution is heating, buff 2 pennies until they are shiny using steel wool. Rinse the pennies in tap water to remove any grit from the steel wool. When the solution is warm enough, use forceps to place the pennies on top of the zinc.

Leave the pennies in the solution until some of them attain a silvery color (this may take anywhere from 5 to 30 minutes, depending on the temperature of your solution). Again using forceps, remove the pennies that have turned a uniform silvery color, rinse them with water, dry them off, and place them on a hot plate for several minutes. Watch the pennies and record your observations. Feel free to keep them if you wish.

Questions:

1. What do you believe has occurred to turn the pennies silver colored? Can you write chemical reaction to describe what has occurred?
2. What happens to the penny when you heat it? Why did this occur? Be sure to explain what is occurring on an atomic scale.

Part III-Taking the work out of polishing silver

Do you have any silver jewelry that isn't looking quite as bright as it used to? Now you can use the power of chemistry to clean it, all you need to do is bring it to lab. (Sounds ominous, but this is legit.)

Silver metal will slowly react with oxygen in the air via a redox reaction to form silver (I) oxide, which is a black solid. This tarnish will slowly build up and the silver loses its characteristic shine. There are silver polishes which are pastes designed to help removed this silver oxide layer, but usually quite a bit of rubbing and buffing is required.

In order to reverse the reaction to form silver oxide and convert it back to silver metal, we must a redox couple that gives a spontaneous reaction. The silver oxide \rightarrow silver is a reduction, so we must find a complimentary oxidation process. In this case we will use aluminum(s) \rightarrow aluminum³⁺ oxidation. If you have a tarnished bit of silver, you can chemically "polish" it by taking a piece of aluminum foil and placing it in the bottom of a large beaker. Place the silver item on top of the aluminum foil. On top of this pour in a hot solution containing sodium chloride and sodium bicarbonate (about a 0.1 M solution should be plenty strong enough.) [If you try this at home remember that sodium bicarbonate is baking soda.] Allow the silver to sit until you are happy with the results. Be sure to look carefully at the foil once you are done. This may help you figure out the final chemical destination for the oxidized aluminum atoms.

Questions:

1. What is the balanced reaction that is occurring?
2. Why is hot water used instead of room temperature water? (There are actually two reasons here.)
3. What is the role of the sodium bicarbonate and salt solutions?
 - a. How does this explain why metal statues near the ocean tend to rust much quicker than ones equally close to the great lakes?

b. Why do the instructions for most cooking pots recommend that you salt boiling water only AFTER you have heated it? What could potentially happen if you didn't?

4. Would this same process work to get rid of copper oxide? Iron oxide? Be sure to justify your answer.

Report

Your lab report this week will be fairly informal and can be done with a partner. You can probably get everything done before you leave the lab if you wish.

For Part I, you should present a table that indicates all of the different voltage measurements that you obtained for the different electrochemical half-cell combinations.

As you likely noticed, you are never able to measure the potential of a single half cell (they are only measured in pairs.) This means that it is impossible to determine the absolute potential for any given half-cell. If one half cell potential could be determined than the rest could be found, because the total potential of the cell is just the sum of the two half cells. Thus if one half cell is defined as a standard, then the rest can be given relative potentials which can be used in calculations. Chemists have defined the reduction of H_3O^+ to H_2 to have a potential of 0.0 V. Once this is done, all the other half cells can be determined relative to this and a convenient table created (See appendix M in your textbook.) Use your collected data to create your own table by defining one of your half cells to have a specific potential and then determine the relative potential of the rest (remember that whether you measured a positive or negative voltage will help you know which way the electrons are flowing in your half-cell.) As you do this, keep in mind that:

$$E_{\text{cell}} = E_{\text{ox}} + E_{\text{red}}$$

And that the reduction potential is just the negative of the oxidation potential or: $E_{\text{red}} = -E_{\text{ox}}$

Once you have created your table, compare the table's predicted values versus the actual measured values you obtained for at least 2 pair of half cells that do not involve your standard half-cell. If they are not consistent, do you have any guess of why they are not? Compare this also to the predicted values from the appendix.

Additionally, answer the questions listed in Parts I-III.

Chemicals:

Copper, magnesium, iron, zinc, aluminum, copper sulfate, magnesium nitrate, sodium chloride, iron chloride, zinc nitrate, aluminum nitrate

Chemical Disposal:

All metal containing solutions should be placed in the appropriate waste bottles. Filter paper can be disposed of in the trash.

APPENDIX B
MULTIPLE INTELLIGENCES STUDENT TEST

Students filled out an online survey using a Likert scale and 56 questions describing the student. The survey analyzed their results and gave them a summary of their top three strengths and listed the order of their other 5 intelligences. The survey can be found on: <http://www.literacyworks.org/mi/assessment/findyourstrengths.html> and is sponsored by the Multiple Intelligences for Adult Literacy and Education.

Multiple Intelligence Online Questionnaire

Participation in this research is voluntary and participation or non-participation will not affect a student's grades or class standing in any way.

Instructions: Read each statement carefully. Choose one of the five buttons for each statement indicating how well that statement describes you.

- 1 = Statement does not describe you at all
- 2 = Statement describes you very little
- 3 = Statement describes you somewhat
- 4 = Statement describes you pretty well
- 5 = Statement describes you exactly

1. I pride myself on having a large vocabulary.
2. Using numbers and numerical symbols is easy for me.
3. Music is very important to me in daily life.
4. I always know where I am in relation to my home.
5. I consider myself an athlete.
6. I feel like people of all ages like me.
7. I often look for weaknesses in myself that I see in others.
8. The world of plants and animals is important to me.
9. I enjoy learning new words and do so easily.
10. I often develop equations to describe relationships and/or to explain my observations.
11. I have wide and varied musical interests including both classical and contemporary.
12. I do not get lost easily and can orient myself with either maps or landmarks.
13. I feel really good about being physically fit.
14. I like to be with all different types of people.
15. I often think about the influence I have on others.
16. I enjoy my pets.
17. I love to read and do so daily.
18. I often see mathematical ratios in the world around me.
19. I have a very good sense of pitch, tempo, and rhythm.
20. Knowing directions is easy for me.
21. I have good balance and eye-hand coordination and enjoy sports which use a ball.
22. I respond to all people enthusiastically, free of bias or prejudice.
23. I believe that I am responsible for my actions and who I am.

24. I like learning about nature.
25. I enjoy hearing challenging lectures.
26. Math has always been one of my favorite classes.
27. My music education began when I was younger and still continues today.
28. I have the ability to represent what I see by drawing or painting.
29. My outstanding coordination and balance let me excel in high-speed activities.
30. I enjoy new or unique social situations.
31. I try not to waste my time on trivial pursuits.
32. I enjoy caring for my house plants.
33. I like to keep a daily journal of my daily experiences.
34. I like to think about numerical issues and examine statistics.
35. I am good at playing an instrument and singing.
36. My ability to draw is recognized and complimented by others.
37. I like being outdoors, enjoy the change in seasons, and look forward to different physical activities each season.
38. I enjoy complimenting others when they have done well.
39. I often think about the problems in my community, state, and/or world and what I can do to help rectify any of them.
40. I enjoy hunting and fishing.
41. I read and enjoy poetry and occasionally write my own.
42. I seem to understand things around me through a mathematical sense.
43. I can remember the tune of a song when asked.
44. I can easily duplicate color, form, shading, and texture in my work.
45. I like the excitement of personal and team competition.
46. I am quick to sense in others dishonesty and desire to control me.
47. I am always totally honest with myself.
48. I enjoy hiking in natural places.
49. I talk a lot and enjoy telling stories.
50. I enjoy doing puzzles.
51. I take pride in my musical accomplishments.
52. Seeing things in three dimensions is easy for me, and I like to make things in three dimensions.
53. I like to move around a lot.
54. I feel safe when I am with strangers.
55. I enjoy being alone and thinking about my life and myself.
56. I look forward to visiting the zoo.

APPENDIX C
PRE AND POST ASSESSMENTS

Entropy & Free Energy

1. What is the ΔG° for the gaseous reaction $\text{N}_2 + 3 \text{H}_2 \rightarrow 2 \text{NH}_3$? ($\Delta G^\circ_{\text{f,nh}_3} = -16.5$ kJ/mol)?
2. If a reaction is spontaneous at 298 K, with a positive value of ΔS , then the reaction is _____.
3. At what temperature will a system where $\Delta H = +9.4$ kJ/mol and $\Delta S = +83.9$ J/g • mol be at equilibrium?
4. According to the second law of thermodynamics, the entropy of the universe -----
-----.
5. The $\Delta G^\circ_{\text{f}}$ of $\text{N}_2(\text{g})$ is -----.

Electrochemistry

1. In a voltaic cell, current flows in which direction?
2. How long would it take to reduce 1.00 g of Ni^{2+} to its metal at 2.00 A?
3. What is E°_{cell} for the reaction $2 \text{Ag}^+ + \text{Zn} \rightarrow 2 \text{Ag} + \text{Zn}^{2+}$?

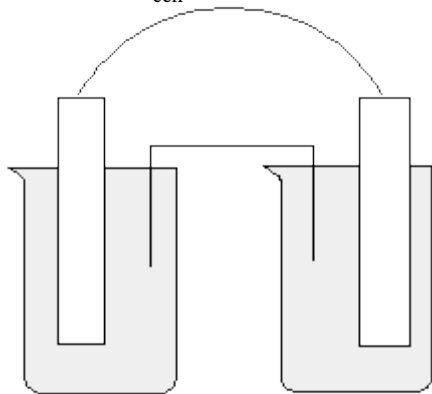

4.

Label the diagram above; anode, cathode, current flow, salt bridge.

IMF's, Liquids, and Solids

1. Under what conditions does a substance become a supercritical fluid?
2. What causes the high surface tension of water?

3. What is the intermolecular force in $\text{MgCl}_2(aq)$?
4. Why are ion-dipole forces stronger than dipole-dipole forces?
5. What is the typical ratio of water molecules to ions with ion-dipole forces?

APPENDIX D

PRE AND POSTUNIT STUDENT CONCEPT INTERVIEWS

Participation in this research is voluntary, and participation or non-participation will not affect a student's grades.

Please think out loud as you create a concept map using the following terms. You can add additional terms and give examples. Connecting statements that you use between each of the terms is also important to making the map.

Nonintervention Unit (Entropy/ Free Energy)

Entropy, Free Energy, Nonspontaneous Process, Reversible Process, Spontaneous Process,

Intervention Unit 1 (Electrochemistry)

Anode, Cathode, electrochemistry, Faraday's Constant, Standard Cell Potential, Standard reduction potential, voltaic cell.

Intervention Unit 2 (Intermolecular Forces)

Capillary Action, Dipole-Dipole, Dispersion Force, Hydrogen Bond, Hydrophobic, Hydrophilic, Ion-Dipole, Polarizability, Surface tension, Temporary Dipole, Van der Waals Forces, Viscosity

APPENDIX E
PRETREATMENT AND POSTTREATMENT STUDENT SURVEY

Participation in this research is voluntary and participation or non-participation will not affect a student's grades or class standing in any way.

Student Name _____

STUDENT SURVEY

1 = Strongly Disagree 2 = Disagree 3 = Not Sure 4 = Agree 5 = Strongly Agree

1. Do you enjoy going to AP Chemistry class? 12345
2. Do you feel engaged and interested during class? 12345
 - a. Please list what engages you during class.
3. Do you feel curious about the concepts that are being discussed? 12345
4. Do you feel confident in your understanding of the material we covered in this unit? 12345
5. Do you feel confident enough to take a quiz on this material, if it were given today? 12345
6. Does your group keep you interested in chemistry? 12345
 - a. What about your group keeps you interested?
7. Is your group effective in helping you learn? 12345
8. Did you feel more engaged by the new group assignments? 12345
9. Did you put more effort in your learning due to the grouping? 12345

POSTTREATMENT

10. *Do you feel your MI group is incorrect? 12345*
 - a. *How do you know the group is correct or incorrect?*

DELAYED

11. Do you feel you still remember information about this concept? 12345

APPENDIX F
PRETREATMENT AND POSTTREATMENT STUDENT INTERVIEW QUESTIONS
AND DELAYED QUESTIONS

Participation in this research is voluntary and participation or non-participation will not affect a student's grades or class standing in any way.

Student Name _____

Student Interview

1. Did you feel engaged in class?
 - a. How could you tell you were more engaged?
 - b. Did you do anything differently?
2. Did you feel the test was easier? Yes or No, Explain.
3. What class activities helped you learn the most? Explain.
4. What class activities keep your interest the most? Explain.
5. What did you enjoy most about this unit? Explain.
6. What did you find most frustrating about this unit? Explain.
7. Is there anything else you would like to tell me about the work you did in class during this unit?
8. What else could you share that could be helpful to myself, as the teacher, or other future students?

POST TREATMENT ONLY

9. *Did you feel your MI evaluation correctly placed you?*
 - a. *Why do you think so?*
 - b. *Did the MI help you to learn? Yes or No, Explain.*

DELAYED

1. Do you feel you retained more information about this concept?
 - a. Why do you think you still remember this?
 - b. Can you give a specific example?
2. What else could you share that could be helpful to myself, as the teacher, or other future students?

APPENDIX G
STUDENT JOURNAL PROMPTS

Thinking about the lesson today please reflect on the following:

Thermodynamics (nontreatment)

Which one of the following pairs of samples has the higher entropy?

- a. $Br_2(l)$ or $Br_2(g)$
- b. $C_2H_6(g)$ or $C_3H_8(g)$
- c. $MgO(s)$ or $NaCl(s)$
- d. $KOH(s)$ or $KOH(aq)$

Please cite evidence and support your answer

Electrochemistry (treatment)

Examine a table of standard electrode reduction potentials and determine whether the following statements are true or false.

- a. *Magnesium will react with water to produce hydrogen gas.*
- b. *A piece of nickel immersed in a solution of silver nitrate will become coated with silver.*
- c. *Nitric acid will oxidize tin to Sn^{2+} , producing nitric oxide, NO.*

Why do you think this is true or false? Please cite evidence and support your answer.

IMF (treatment)

Describe the interparticle forces at work in the following:

- a. *within a water molecule H_2O*
- b. *in a crystal of the salt $NaCl$*
- c. *in a solution of potassium nitrate KNO_3*
- d. *in diamond*
- e. *between water molecules in ice*
- f. *between the molecules of carbon dioxide CO_2 in dry ice*
- g. *between the molecules of HCl in liquid HCl*

h. in tungsten metal

Please cite evidence and support your answer.

APPENDIX H
TEACHER JOURNAL

Teacher Journal Prompts:

On a scale of 1 – 5 with 1 being little and 5 being very much or (high).

Do you feel the students understood the lesson today or were they lost? Explain.

Were there any effects on the students today during class? Such as a “DING” moment

On a scale of 1 – 5 with 1 being little and 5 being very much or (high).

Specifically thinking about your low achievers, did they improve their understanding of the concept today? Explain.

Did any low-achieving students show improved learning today? Which ones? What were they doing?

On a scale of 1 – 5 with 1 being little and 5 being very much or (high).

Did you scaffold material from first semester with today’s concept? Explain.

Did you talk about any previous material today from first semester? Did they remember or did they bring it up?

On a scale of 1 – 5 with 1 being little and 5 being very much or (high).

Do you feel the class was completely engaged to day? Explain.

Please elaborate on how you could tell?

APPENDIX I
CLASSROOM OBSERVATION INSTRUMENT

NONTREATMENT OBSERVATION

| Behaviors/ Activities | Group I | Group II | Group III | Group IV | Group V |
|--|---------|----------|-----------|----------|---------|
| All members actively participate | | | | | |
| Group members are respectful of one another | | | | | |
| Group members attempt to complete work on their own before asking me asking teacher questions. | | | | | |
| Group stays on task. | | | | | |
| Additional Observations | | | | | |

Additional comments:

TREATMENT OBSERVATION

| Behaviors/ Activities | Homo Spatial Group I | Homo Linguistic Group II | Homo Linguistic Group III | Homo Bodily- Kinesthetic Group IV | Homo Bodily- Kinesthetic Group V |
|---|----------------------------|--------------------------------|---------------------------------|--|---|
| All members actively participate | | | | | |
| Group members are respectful of one another | | | | | |
| Group members attempt to complete work on their own before asking me asking teacher questions. | | | | | |
| Group stays on task. | | | | | |
| Additional Observations | | | | | |
| | | | | | |
| Behaviors/ Activities | Hetero Group I | Hetero Group II | Hetero Group III | Hetero Group IV | Hetero Group V |
| All members actively participate | | | | | |
| Group members are respectful of one another | | | | | |
| Group members attempt to complete work on their own before | | | | | |

| | | | | | |
|-------------------------------------|--|--|--|--|--|
| asking me asking teacher questions. | | | | | |
| Group stays on task. | | | | | |
| Additional Observations | | | | | |

APPENDIX J
NONTREATMENT AND TREATMENT OBSERVATIONS BY COLLEAGUES
WITH PROMPTS

Date: _____ Time: _____ Observer: _____

Please describe the flow of class activities

Beginning Middle End

For each of the following, please select the best response for the class as a whole, and for a specific **kinesthetic**, **spatial**, and **mixed** group.

1 = Strongly Disagree 2 = Disagree 3 = Not Sure 4 = Agree 5 = Strongly Agree

Explain your responses.

1) Students were attentive and on task for the majority of the class.

Class 5 4 3 2 1

Kinesthetic 5 4 3 2 1

Spatial 5 4 3 2 1

Mixed 5 4 3 2 1

Explain

2) Students had a positive attitude in class.

Class 5 4 3 2 1

Kinesthetic 5 4 3 2 1

Spatial 5 4 3 2 1

Mixed 5 4 3 2 1

Explain

3) Students were curious about the class topic.

Class 5 4 3 2 1

Kinesthetic 5 4 3 2 1

Spatial 5 4 3 2 1

Mixed 5 4 3 2 1

Explain

4) Students asked questions that applied to the class topic.

Class 5 4 3 2 1

Kinesthetic 5 4 3 2 1

Spatial 5 4 3 2 1

Mixed 5 4 3 2 1

Explain

5) The teacher seemed enthusiastic about the class. 5 4 3 2 1

Explain

6) What was the best part of the class? Explain.

7) What could be improved about this class? Explain.

APPENDIX K

PRETREATMENT AND POSTTREATMENT TEACHER SURVEY

Teacher Survey

1 = Strongly Disagree 2 = Disagree 3 = Not Sure 4 = Agree 5 = Strongly Agree

1. Students were attentive and on task. 1 2 3 4 5

Elaborate or give example:

2. Students had a positive attitude in class. 1 2 3 4 5

Elaborate or give example:

3. Students were curious about the class topic. 1 2 3 4 5

Elaborate or give example:

4. Students asked questions that applied to the class topic. 1 2 3 4 5

Elaborate or give example:

5. I look forward to working with my students (grouped or whole class) 1 2 3
4 5

Elaborate or give example:

6. I look forward to going to class. 1 2 3 4 5

Elaborate or give example:

7. I am excited about the learning that is occurring in my classroom. 1 2 3 4 5

Elaborate or give example:

APPENDIX L
PROJECT TIMELINE

Project Timeline

Start Project Implementation: January 21, 2014

2 weeks- Nontreatment unit with Routine Teaching Strategies on Thermodynamics

January 21-31 Class Instruction, Labs and Problem Sets

January 21-Nontreatment preunit Assessment, Class Instruction and problem set
Enthalpy and Calorimetry, teacher journal

January 23- Class Instruction and problem set; Hess's Law, Enthalpy of Formation and
Bond Energy, teacher journal

January 27 LAB, – Calorimetry Lab, teacher journal

January 29 Class Instruction and problem set; Entropy and Free Energy, teacher journal,
student journal

January 31 Review and postunit ASSESSMENT, pretreatment student survey and
interviews, teacher survey

2 weeks- Treatment Unit 1 with Intervention Electrochemistry

February 4- 14 Class Instruction, Tutorial Instruction, Lab and Problem Sets

February 4- Treatment preunit Assessment, MI homo-grouping; Electrochemical series
lab, Problem Set and Tutorial Presentation. Observation, teacher journal,

February 6- MI Hetero-grouping modified lecture & problem set voltaic (galvanic) cells,
Voltage, standard reduction potentials and standard cell potentials (half period) and
demo (electrochemical series) and data presentation from original homo-group members
(half period). Observation, teacher journal

February 10- MI Hetero-grouping lecture and problem set; Spontaneous REDOX
reactions, Gibbs Free Energy, Concentration Cells, and Electrolytic Cells, teacher journal

February 12- MI Hetero-grouping lab Measurements using Electrochemical Cells, gas
collection and electroplating, teacher survey, student journal

February 14- Review, Post unit assessment, posttreatment student survey and interviews.
Delayed thermo assessment

2 weeks – Treatment Unit 2 with Intermolecular Forces

February 18- Treatment preunit Assessment, MI homo-grouping; Chromatography Lab, Problem Set and Tutorial Presentation, teacher journal, observation

February 20- MI Hetero-grouping modified lecture & problem set Types of Intermolecular Forces and determining relative boiling points (half period) and demo (chromatography lab) and data presentation from original homo-group members (half period). Teacher journal, observation

February 24- MI Hetero-grouping modified lecture & problem set; heat of fusion, heat of vaporization, vapor pressure, phase diagrams, teacher journal, observation

February 26- MI Hetero-grouping modified lecture & problem Unit Cells, Molecular Solids, Covalent Solids and Metallic Solids, teacher survey, student journal

February 28- Review, Post assessment and posttreatment student survey and interviews, delayed electro assessment

March 14- delayed IMF assessment

End Project Implementation: March 14, 2014

