

NGSS FORMATIVE ASSESSMENT IN MIDDLE SCHOOL SCIENCE

by

Lori Kay Stanton

A professional paper submitted in partial fulfillment  
of the requirements for the degree

of

Master of Science

in

Science Education

MONTANA STATE UNIVERSITY  
Bozeman, Montana

July 2017

©COPYRIGHT

by

Lori Kay Stanton

2017

All Rights Reserved

## ACKNOWLEDGEMENT

I would like to thank the faculty and my fellow students in the MSSE program for all their support. I would also like to thank my three children: Peter, Gail, and Sarah Stanton for their unswerving encouragement and support while I have been in this program.

## TABLE OF CONTENTS

1. INTRODUCTION AND BACKGROUND .....	1
2. CONCEPTUAL FRAMEWORK .....	3
3. METHODOLOGY .....	6
4. DATA AND ANALYSIS .....	12
5. INTERPRETATION AND CONCLUSION .....	21
6. VALUE .....	25
REFERENCES CITED.....	28
APPENDICES .....	32
APPENDIX A Crosscutting Concept Posters.....	33
APPENDIX B Science and Engineering Practice Posters.....	35
APPENDIX C Institutional Review Board Approval.....	37
APPENDIX D Modified Classroom Test of Scientific Reasoning .....	39
APPENDIX E FOSS Chemical Interactions Unit Test.....	45
APPENDIX F FOSS Heredity and Adaptations Pre-test and Posttest .....	53
APPENDIX G NGSS SEP and CC Confidence Survey.....	61
APPENDIX H Claim Evidence Reasoning (CER).....	65
APPENDIX I Claim Evidence Reasoning Rubric .....	67
APPENDIX J Formative Assessment Fossil Record.....	69
APPENDIX K Formative Assessment Homologous Structures.....	71
APPENDIX L Formative Assessment Phylogenetic Tree I .....	73
APPENDIX M Formative Assessment Phylogenetic Tree II.....	75
APPENDIX N Formative Assessment Phylogenetic Tree III .....	77
APPENDIX O Formative Assessment Embryology.....	79
APPENDIX P Formative Assessment Mutation and Natural Selection.....	82
APPENDIX Q Formative Assessment Pedigree Chart.....	84
APPENDIX R Formative Assessment Rubric .....	86
APPENDIX S Teacher Journal .....	88

LIST OF TABLES

1. Data Triangulation Matrix .....	11
2. Summary of the Chi Square Statistic for the SEP's.....	15
3. Mean Score Summary for CER Paragraphs.....	17
4. Summary of Mean Score for Selected Formative Assessments .....	20

## LIST OF FIGURES

1. NGSS SEP and CC Notebook Example .....	7
2. Classroom Test of Scientific Reasoning Pre-test and Posttest.....	12
3. Classroom Test of Scientific Reasoning Pre and Posttest Comparison.....	13
4. Chemical Interactions Post-test and Treatment Unit Posttest Comparison .....	14
5. Pre-treatment and Post-treatment Responses to the SEP Confidence Survey .....	15
6. Claim Evidence Reasoning Scores for Nov-April.....	17
7. Crosscutting Concept Choices for Formative Assessments.....	18

## ABSTRACT

School districts across the country are in the process of adopting the Next Generation Science Standards, or a version of them. This will significantly change the way we teach as well as the content we teach in the years to come. The purpose of this study was to investigate the effect of instruction in the three dimensions of the Next Generation Science Standards on student academic achievement as well as student comfort with crosscutting concepts and science and engineering practices language. It was found that there was a significant improvement in student comfort and use of language. While there was not a significant increase in content knowledge, students showed improvement in Claim-Evidence-Reasoning paragraph writing.

## INTRODUCTION AND BACKGROUND

Twin Falls Middle School (TFMS) is a relatively new school in the Snoqualmie Valley School District (SVSD), having just opened in 2008. The school district is relatively small, serving about 6,800 students in grades K-12 (OSPI Washington State Report Card, n. d.). In 2015, the district had a 92% high school graduation rate, with about 78% of those students choosing to attend a two or four year college (High School Feedback Reports, 2014). The district's mission is "to prepare all students for college, career and citizenship." For the past ten years, the SVSD has grown an average of 3% per year (District Overview, 2016).

SVSD has emphasized teacher collaboration and professional development as a way to provide an excellent education to its students, with teachers at my school having a planning period each day, and a second period each day to meet with staff. We meet regularly with administration, two school counselors, special education teachers, and our grade level teachers. The district has also made curriculum development a priority. The district has eagerly adopted the Next Generation Science Standards (NGSS Lead States, 2013), and provided time and opportunities for science teachers to study the NGSS and work together to implement them in our classrooms.

Twin Falls is one of two middle schools in the district, with 748 students enrolled this school year. Twin Falls is the eastern-most school in the Snoqualmie Valley School District, located against the foothills of the Cascade Mountains of Washington State (TFMS School Profile). Students come from a variety of backgrounds. We have students whose parents commute into the Seattle/Bellevue area to work as well as



students living in homeless shelters (M. Botulinski, personal communication, March 29, 2017). Twin Falls has a predominantly white population (86%) with smaller populations of Hispanic and mixed race students. Twin Falls has a slightly higher than district average of free and reduced-price meal population (District Overview, 2016). The school is growing rapidly, averaging over 20 new students a year for the past 4 years (D. Stevens, personal communication, March 29, 2017). Twin Falls won Washington State Achievement Awards in various categories such as high progress, reading growth, and overall excellence and at different levels in 2011, 2012, 2014, and 2015 (TFMS profile).

Faculty at Twin Falls has an average of 11.5 years of teaching experience. With three new teachers this year, only one teacher is a first year teacher (OSPI Washington State Report Card). The vision statement of Twin Falls states that “Twin Falls Middle School is a safe, accepting learning community that prepares middle school students to be respectful, resourceful, educated citizens” (TFMS School Improvement Plan). Teachers at Twin Falls have worked hard to establish programs for student academic success. This year the school is implementing Advancement Via Individual Determination (AVID), a program to increase college readiness through support and accountability. There is an established natural helpers (peer counseling) program, Friends of Youth counselors visit the school, and an established RTI program that is effectively working to monitor and intervene with students struggling both academically and behaviorally (TFMS School Profile).

This is my first year teaching at Twin Falls. It has been a big change, going from teaching mostly high school biology to integrated eighth grade science, private to public

school, and an urban district to a more rural district. I had been teaching at my previous high school for nine years. One of the big attractions to working in this district, and with this particular administration was the support offered to teachers to innovate and collaborate with others. When I was hired last spring, it was clear that the NGSS was a priority with the science department. This was exciting because my background training in the Process Oriented Guided Inquiry Learning (POGIL) teaching method had already given me a strong interest in focusing on the science and engineering practices and crosscutting concept ideas with students.

In the MSSE program we have been introduced to different styles of formative assessment in the EDCI 505 class. This emphasis on what a classroom teacher can do in a classroom with students to assess what students know, and to use that data to inform instructional decisions made this a natural focus for my study. Combining the Science and Engineering Practices and Crosscutting Concepts with formative assessment interests led to the research question: *what is the effect of using the three dimensions of the Next Generation Science Standards as a part of formative assessment in the middle school science classroom?*

### CONCEPTUAL FRAMEWORK

Since the Soviet Union launched Sputnik into space, there has been concern in the United States about the preparation of our students in the areas of math and science. There have been initiatives to make sure that our students are the “best” and able to compete with their peers around the world (Bybee & Fuchs, 2006). Science, engineering and technology are integral parts of our everyday lives, and have the possibility of

solving many problems either locally or in our world today (National Research Council, 2007). Despite these efforts and potential pay-offs, our students have not achieved on standardized tests at the top levels compared to students from some other countries (Desilver, 2015). The National Research Council (2012) developed *A Framework for Science Education K-12: Practices, Crosscutting Concepts, and Core Ideas*, with the intent to use research to identify ways that students learn most effectively, to align science instruction more like the way scientists actually work, and to detail the scientific knowledge that students should all know so that they are able to contribute effectively in society.

This document was the foundation for the Next Generation Science Standards (NGSS) that are being explored and adopted by states. The NGSS is composed of three dimensions: the disciplinary core ideas (DCI), the science and engineering practices (SEP), and the crosscutting concepts (CC). These three dimensions of science learning together allow students to explore content knowledge, the practices of scientists and engineers, as well as the unifying concepts that link content knowledge with other subject areas and the real world (NGSS Lead States, 2013).

The authors of the Framework and the NGSS have articulated the need for reform in educational practices in order to implement new teaching strategies as well as to assess student learning outcomes. Both of these reforms are underway in many states, and it is the “hot” topic at professional development conferences across the country. Typically, proficiency on standardized testing at the state level has focused on what is the DCI component of the NGSS standards (National Research Council, 2014). With adoption of

NGSS, states now face challenges as they consider how to determine student proficiency in science within this new framework. Methods to assess science proficiency as a whole, including assessment of a student's progress in Science and Engineering Practices, as well as Crosscutting Concepts need to be developed (Furtak et al., 2016). Attention needs to be given to professional development for teachers using these tools as well (National Research Council, 2014).

One of the recommendations coming from the National Research Council is to include a component for formative assessment where students and teachers both have a chance to reflect on learning and make changes (National Research Council, 2014). This is based on the recognition and expectation that students' thinking and understanding evolve over time (National Research Council, 2007). Formative assessment in the classroom helps to make student thinking visible which allows teachers to make instructional decisions moving forward, and also shows student progress over time (Heritage, 2010; Moulding et al., 2015; Dozier, 2015). Previous research has shown that formative assessment is one of the greatest stimuli to student learning gains, particularly among low achieving students (Black & Wiliam, 1998).

Formative assessment has been defined as assessment for learning as opposed to assessment of learning (Ruiz-Primo & Furtak, 2007; Underwood, 2012). This involves an ongoing process of students receiving feedback on their learning, teachers making adjustments to their teaching, self-assessment and reflection on the part of students (Heritage, 2010; McManus, 2008). As teachers move to implementing the three dimensions of the NGSS, they also need to formatively assess student progress in those

three dimensions. Tools are being developed to assist teachers with creating formative assessments for their own use (Cafarella, 2015). Dozier (2015) suggests that teachers start small with assessment already being used, and begin to incorporate new pieces that would assess all dimensions. Some important considerations are that; assessments consist of multiple questions or components, have a system of interpretation that demonstrates a range of student thinking, and include all three dimensions of the NGSS (National Research Council, 2014; Lloyd, 2016). Angelo and Cross also noted that the cornerstone of formative assessment is to focus on student learning and improving student learning, as opposed to the more traditional focus of improving teaching (Angelo and Cross, 1993).

#### METHODOLOGY

The subjects in this study were students in my third, fourth, and fifth period sections of eighth grade integrated science at Twin Falls Middle School ( $N=75$ ). This is a required course for all students. The curriculum was composed of a life, Earth, and physical science unit during the year. The classes were composed of a range of students from high achievers with supportive parents to students with special needs, homeless students, and those with little support. All students were enrolled throughout the entire study period, however, fifteen students were excluded from the study due to frequent absences that caused them to miss more than two assessments. Students were informed before administration of each data collection instrument that results of that particular test would not impact their grade, and participation was optional.

During this study, lessons exposing students to the three dimensions of the Next Generation Science Standards (NGSS) were given. For science and engineering practices (SEP's) students watched portions of the Bozeman Science videos on each topic (Anderson, 2017). For crosscutting concepts (CC's) students completed short activities. For example, for patterns, students solved codes, sorted objects and challenged each other to find the pattern. For stability and change we looked at balancing objects, and participated in a tug of war. As we looked at the parts of a bicycle, we thought about systems, and structure and function. Formative assessments were designed and used that contained all three dimensions of the NGSS. Posters displaying the SEP's and CC's were displayed in the room for reference, and smaller versions were put in student notebooks (Figure 1). Copies of the posters may also be viewed in Appendices A and B.

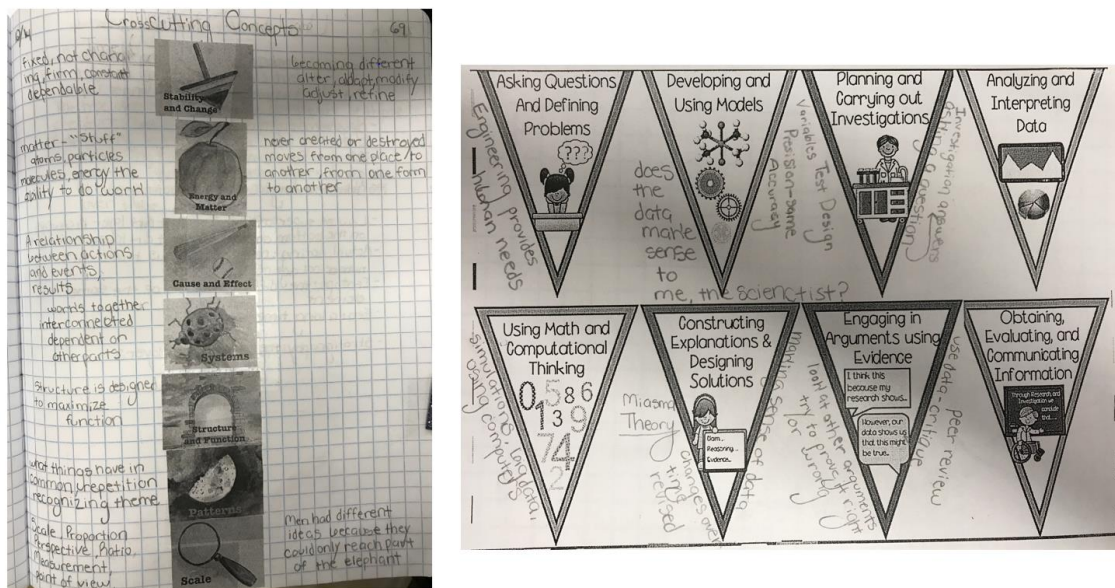

Figure 1. NGSS SEP and CC notebook example.

Research methodology for this project received an exemption by Montana State University's Institutional Review Board and compliance for working with human subjects was maintained (Appendix C).

A modified version of The Classroom Test of Scientific Reasoning (Lawson, 2000) was administered as a pre-test in December 2016 (Lawson, 2000). It was used with permission and shortened from the original version with some slight vocabulary changes to make the test more user-friendly for eighth grade students (Appendix D). The test was administered through Survey Monkey in order to collect and organize responses. Responses to each question as well as overall scores were analyzed. This test was administered again at the beginning of March as a posttest. Pre and post treatment results were analyzed according to Hake's method for normalized gains to determine students' changes as a proportion of possible change in thinking, with values of  $g < 0.3$  as low,  $0.3 < g < 0.7$  considered average gains, and  $0.7 < g$  considered high gains (Hake, 1998). Results were reported in a box-and-whisker plot, and a Wilcoxon Signed-rank test was performed to calculate support for significant change between the pre- and post-treatment tests.

Before treatment began, a unit test on Chemical Interactions from Full Option Science Systems (FOSS) was administered to students (Appendix E). It was analyzed for descriptive statistics and reported as a histogram. Results of this test were used as a comparison with the posttest for the treatment unit of FOSS Heredity and Adaptations (Appendix F). This comparison was judged to be worth making because the Chemical Interactions unit had covered more than a quarter, with intermediate quizzes along the

way, so the opportunity for students to practice and test were thorough. Students had enjoyed the activities, and were interested in introduced concepts. Therefore, it was decided that it would be useful to compare scores from that unit with the treatment unit. Results were analyzed according to Hake for normalized gains ( $g < 0.3$  being judged as low,  $0.3 < g < 0.7$  as average gains, and  $0.7 < g$ , as high gains). The Wilcoxon Signed-rank test was performed to ascertain significant change.

Before treatment of three dimensional formative assessments began, students were also give a Likert style pre-test, the NGSS SEP and CC Confidence Survey, concerning their ability to use both dimensions of the NGSS (Appendix G). In this scale, one point was given for *not confident*, two points were awarded for *slight confidence*, three points represented *confident*, and four points signified *very confident*. At the end of the treatment period, the test was given again as a posttest. Responses from pre- and post-treatment SEP and CC surveys were converted to percentages due to differences in the number of students responding, and unmatched data. The results for each were analyzed for independence using the Chi-Square test with a confidence level of 0.95, and reported in a stacked bar chart.

An important assessment tool for Twin Falls Middle School Science Department is the Claims-Evidence-Reasoning (CER) paragraph (Appendix H). Students were asked to write a CER paragraph about the nature and behavior of particles as a pre-test before treatment began. This was compared with a CER paragraphs written by students in February, March, and in April, the end of the treatment period. The paragraphs were scored with a rubric (Appendix I). The first area scored was for including the Claim,



Evidence, and Reasoning portions of the argument. Four points were awarded for *complete* answers, three, two or one point was awarded for *partial* answers, and no points were awarded if that component was missing. In addition, paragraphs were analyzed for use of vocabulary that would indicate the student was thinking of a SEP, or CC such as using the word, “pattern.” Two points were awarded for *multiple mentions*, one point for *single mention*, and zero points for *no mention* of a SEP or CC. The results of all four CER paragraphs were aggregated for the group, and the mean for each component was reported in a bar plot. The data was analyzed for significance with a two sample t-test.

As students progressed through the unit, formative assessments were given several times. Each formative assessment included assessment of content as well as the use of vocabulary of the SEP’s and CC’s (Appendices J-Q). These formative assessments were scored with a rubric (Appendix R) and analyzed for themes among students.

A teacher journal was kept weekly as a place to record observations and thoughts (Appendix S). This was completed throughout the week during the treatment period as needed. It was analyzed for common themes and used as a comparison to results from other data sources. A summary of data collection strategies is in Table 1.

Table 1  
*Date Triangulation Matrix*

What is the effect of using the three dimensions of the Next Generation Science Standards as a part of formative assessment in the middle school science classroom?						
Sub Questions	Unit pre/post tests	Rubric scores of formative assessment	Classroom Test of Scientific Reasoning pre/post test	CER rubric scores	Likert survey of pre/post SEP and CC confidence	Teacher journal
Does knowing the 3D make a difference in student achievement?	x	x	x	x		x
Are students more comfortable with one dimension of NGSS than others?		x			x	x
How does instruction and familiarity with the 3D's impact students use of SEP, CC vocabulary?		x	x	x	x	x

### DATA AND ANALYSIS

Comparing the mean score of the pre-treatment ( $N=67$ ) and post-treatment scores ( $N=67$ ) for the Classroom Test of Scientific Reasoning (CTSR) shows a gain of 1 point. Out of 14 possible points, the mean for the pre-test was 7, and the posttest was 8. It can be seen from looking at the histograms in Figure 2 that data distribution is not normal for either pre- or the post-treatment tests.

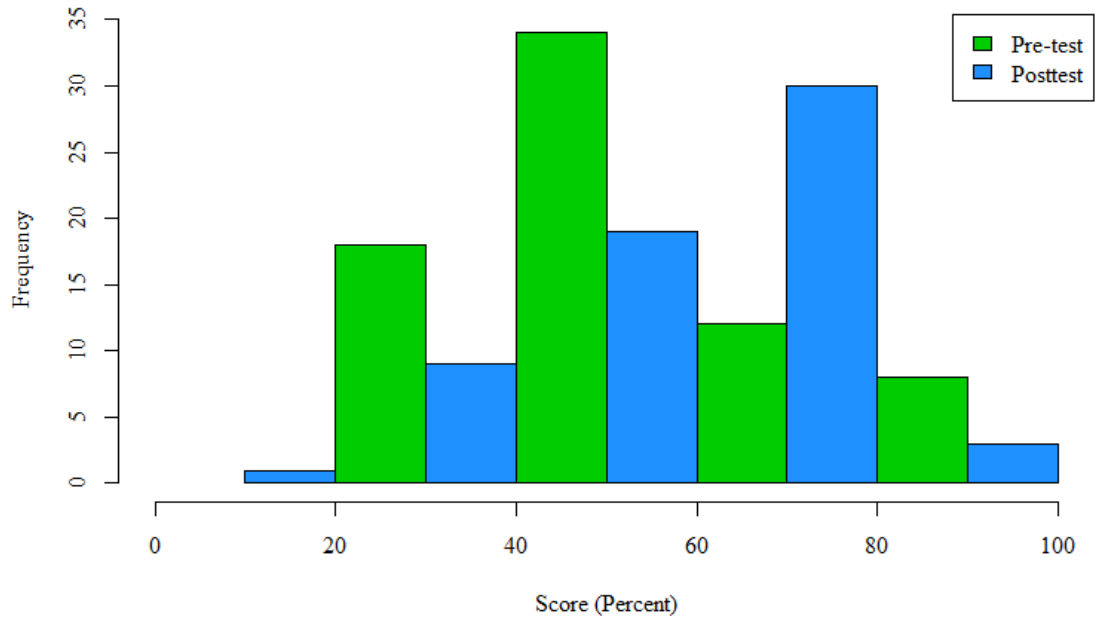

*Figure 2.* CTSR pre-test and posttest, ( $N=67$ ).

Because data distribution was not normal, data was analyzed using the Wilcoxon Signed-rank test, which determined that the p-value (0.15) was not significant at a 95% confidence level. A calculation done for normalized gains found an average normalized gain of -0.02, a negative gain. Scores for the two tests are presented in Figure 3.

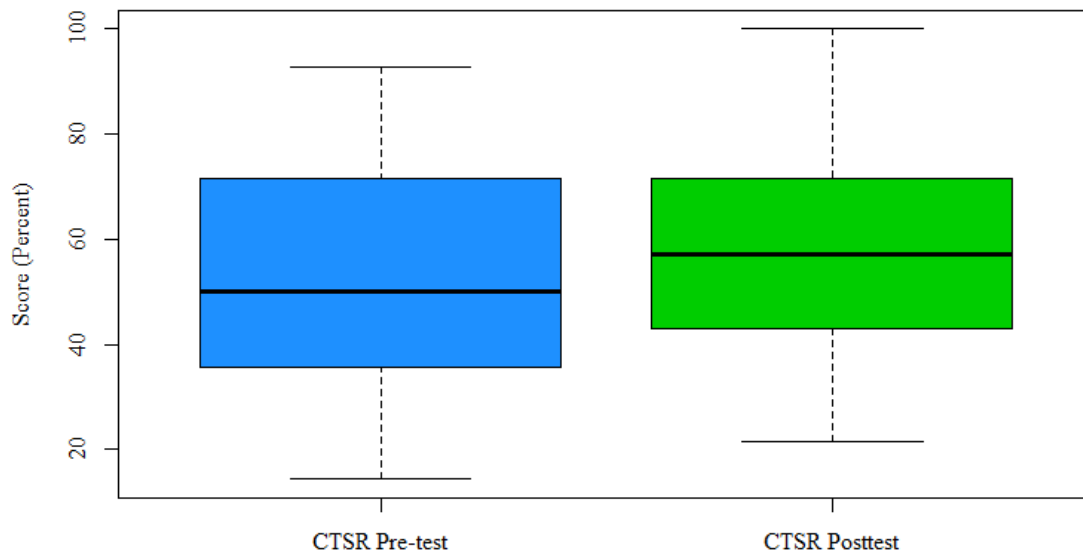

Figure 3. CTSR pre-test and posttest comparison, ( $N=67$ ).

Test scores from the pre-treatment unit on Chemical Interactions and the treatment unit posttest are presented in Figure 4. The treatment unit posttest mean was 78.2, with a median of 82.8 and a standard deviation of 17.2. The mean of the pre-treatment unit test was 77.2, with a median of 79.7 and a standard deviation of 14.6. A Wilcoxon Signed-rank test was performed to see if there was a significant difference between the results of the Chemical Interactions unit posttest and the treatment posttest. A p-value of 0.47 was obtained. At a 95% confidence level, this would indicate there is no significant difference between pre-treatment and treatment unit scores. Using Hake's method for calculation of normalized gains, a negative value for  $g$  of -0.63 was obtained.

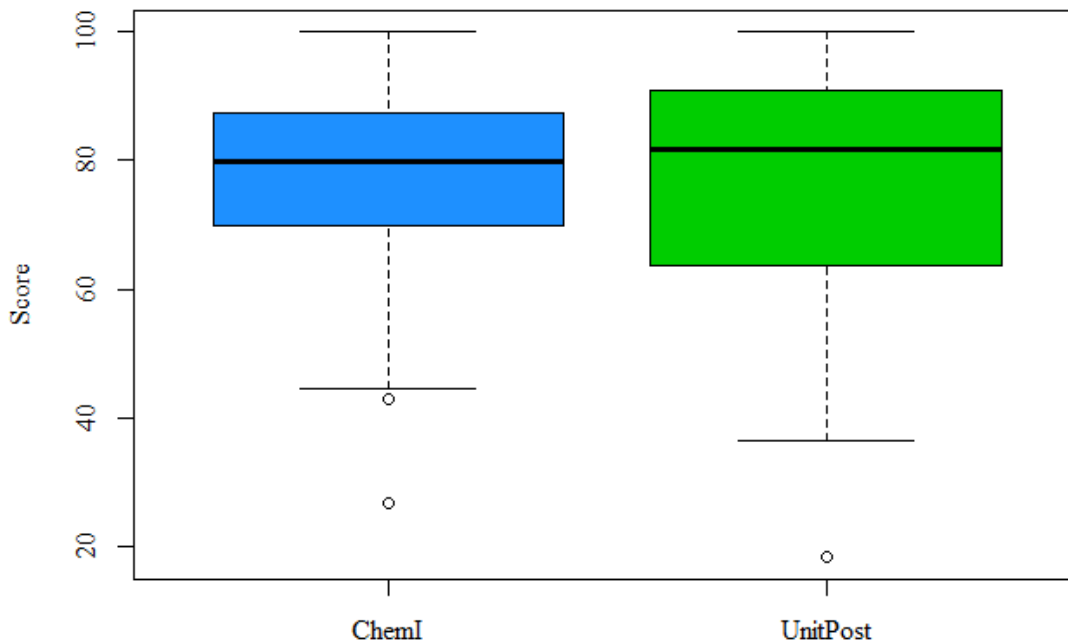

Figure 4. Chemical Interactions posttest and Treatment unit posttest, ( $N=73$ ).

Responses for question one about the SEP's from pre- and post-treatment SEP and CC surveys were evaluated using the Chi-Squared Test of Independence (Figure 5 and Table 2). A p-value of 0.05 was used, the degree of freedom was three, and the critical value was 7.81 (Christmann, 2012). Each individual science practice was analyzed for independence, as well as a total of the seven practices pre- and post-treatment. In none of these cases was the critical value met or exceeded; indicating no significant difference between pre-treatment and post-treatment results.

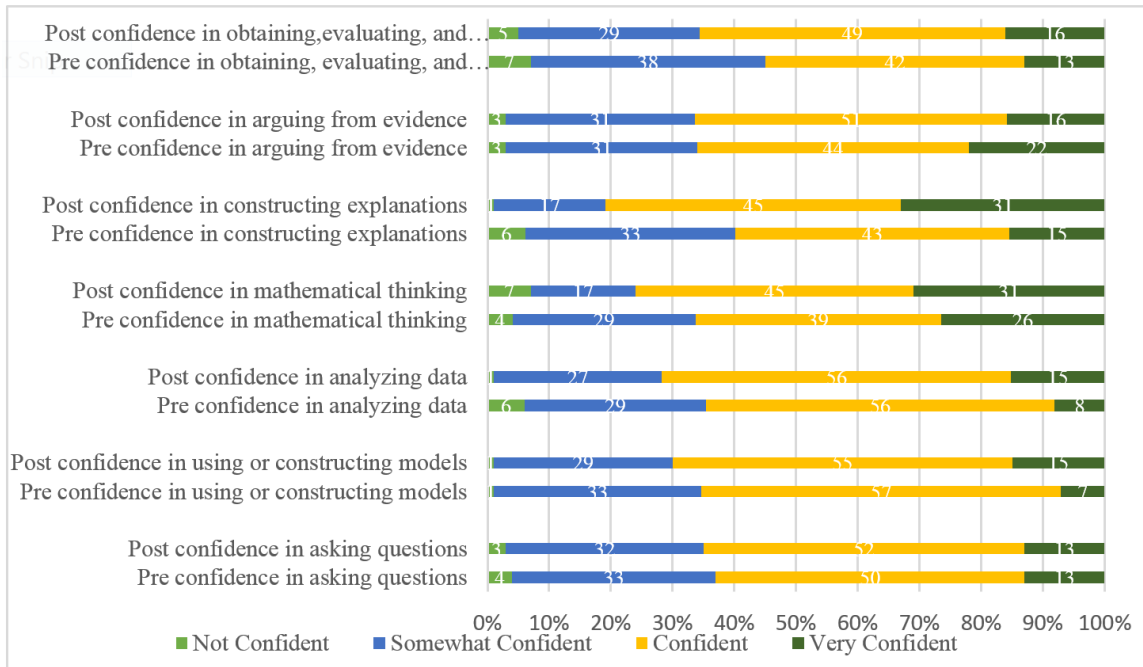

Figure 5. Pre- and post-treatment responses to SEP Confidence Survey, (Pre N=72, Post N=75).

Table 2  
Summary of the Chi Square Statistic for the SEP's

Science Practice	Chi Square (X <sup>2</sup> )
Communicating Info	1.67
Arguing Evidence	1.05
Constructing Ex.	3.99
Tools, Tech, Data	3.28

Science Practice	Chi Square (X <sup>2</sup> )
Math Thinking	3.24
Models	2.22
Asking Questions	2.59
Total	4.94

Note: Critical value is 7.81.

Question two concerning crosscutting concepts and disciplinary core ideas was not analyzed. During the course of the unit, students were asked to self-assess their understanding of disciplinary core ideas with an exit ticket. Comments were made such as “whatever” or “I don’t know what all these words mean.” It became clear that the students did not understand the vocabulary of the Disciplinary Core Ideas as published, and that their responses in the survey were, in many cases, random guesses.

Four Claim Evidence Reasoning (CER) paragraphs were given and evaluated throughout this study period. The first CER was given prior to the treatment period, two were given during the treatment period, and the final CER was given about two weeks after the treatment unit ended. Two claims, initial and final, written by the same student are shared below.

November: “Claim: When particles are heated they spread out and move around faster, and when particles are cooled, they contract and slow down.”

April: “Some factors that cause heat to move from place to place are air currents and water currents. This is an example of the crosscutting concept of patterns because air currents move around the world in a pattern, while the ocean currents also move around in a pattern.”

A two-sample t-test was performed to evaluate the significance of the difference between the November (initial) and April (final) CER’s. A p-value of 0.00 was obtained for all three comparisons of the strands of the CER (claim, evidence, and reasoning). This is less than the 0.05 confidence level, indicating a significant difference between November and April.

Scores for the claim section of the CER paragraphs showed the largest gain, improving from 2.52 to 3.37, and was the only section to show continuous improvement (Figure 6 and Table 3). Mean scores for the evidence section of the CER’s improved from 2.71 to 3.12, between November and February, and showed little to no change between February and April. Similarly, mean scores for the reasoning portion of the CER’s increased from between February and March but showed no change for the last two trials.

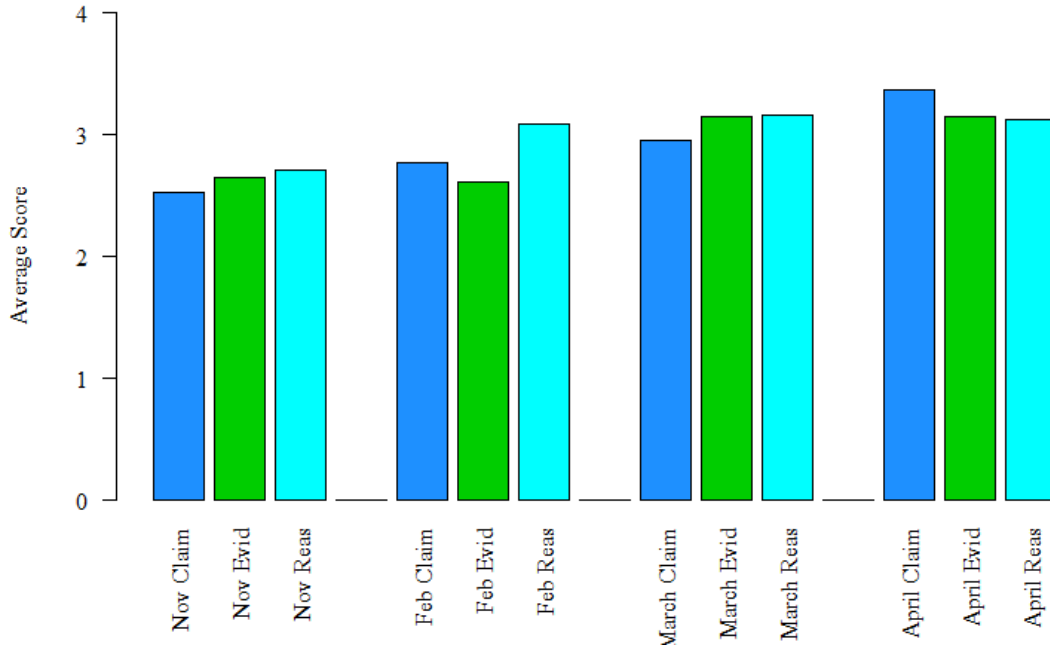

Figure 6. Claim-Evidence-Reasoning scores for Nov-April, (N= 75, 69, 83, 72).

Table 3  
Mean Score Summary for CER Paragraphs

	Claim	Evidence	Reasoning
November- Particle spacing	2.52 (63%)	2.71 (68%)	2.65 (66%)
February- Biodiversity	2.77 (69%)	3.10 (78%)	2.61 (65%)
March -Theory of Evolution	2.95 (74%)	3.16 (79%)	3.14 (79%)
April -Moving Heat	3.37 (84%)	3.12 (78%)	3.15 (79%)

Note: Total score possible in each category was 4.

CER paragraphs were also evaluated for use of SEP and CC language with a rubric (Appendix G). In November, the mean score was 0.56 out of 2 (Figure 7). Means consistently improved throughout the treatment period; 0.99 in February, 1.2 in March, and 1.6 in April, an increase of 286%.



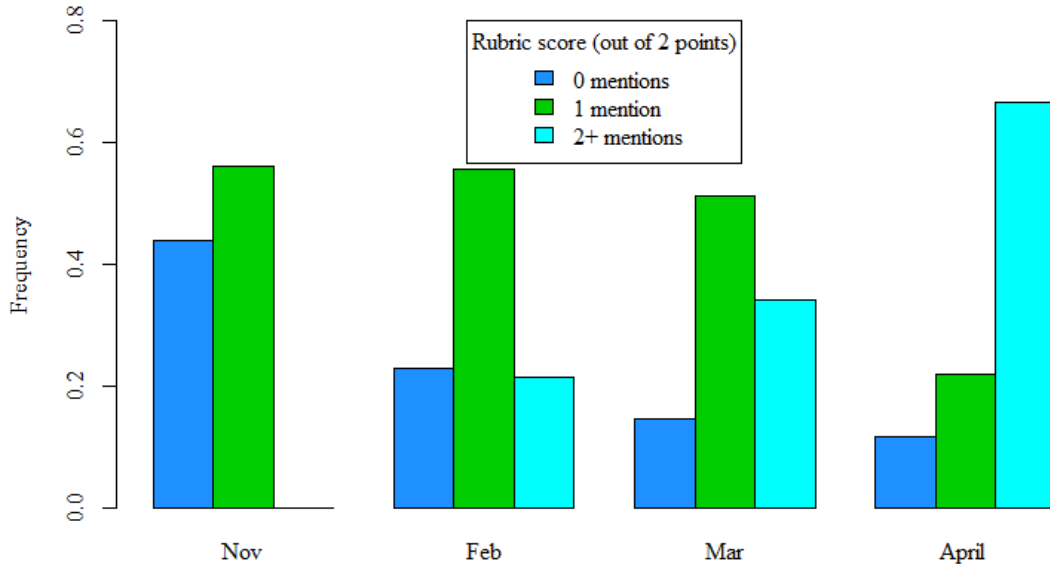

Figure 7. SEP and CC rubric scores for CER paragraphs, (N=73, 70, 73, 73).

The percentage of students receiving a zero score in November was 44%, which dropped to 12% in April. The percentage of students receiving a two in November was 0%, which increased to 67% in April. The largest increase in the percentage of students receiving a score of two was between March at 38% and April at 67%. This coincides with direct instruction giving examples of ways to include SEP or CC vocabulary more fluidly in a writing sample. The November and April writing samples were analyzed with a two sample t-test to determine support for significant change. A p-value of 0.00 was obtained, indicating significant improvement

In the November CER writing samples, crosscutting concepts such as cause and effect had to be inferred in student's writing from phrasing such as: ".....when the

particles were being heated.....because.....” or “.....as the temperature cooled, the less room needed, so.....”

In February, one student directly stated that “we used Science and Engineering Practices and analyzed and interpreted data.” And by April, students were able to directly state a variety of crosscutting concepts and a few science and engineering practices. One student wrote:

“Factors that are causing heat to move from place to place are global wind and ocean currents. This is an example of the crosscutting concepts of patterns and systems. From the global winds mapping activity, hot air was shown to rise into the atmosphere, then cool, falling back to the Earth’s surface. This is important because it illustrates the process of thermal energy being redistributed to the Earth’s surface through atmospheric circulation (wind cells). This is an example of energy and matter. Another piece of evidence is.....”

Formative assessments were given between the second week of the treatment unit through the last week of the treatment unit. Scores were recorded for each of the three NGSS dimensions, and mean scores for two formative assessments are summarized in Table 4. A score of two points indicated multiple appropriate mentions of the dimension, one point indicated one mention, and zero indicated no mention of that dimension. Scores on the SEP and CC sections of the formative assessments showed significant improvement; the Crosscutting Concept strand improved 25% and the Science and Engineering Practices strand increased 62%. A two sample t-test showed a p-value of less than 0.01 for both the CC’s and SEP’s indicating a significant difference from beginning to end of the treatment unit.

Table 4  
*Summary of Mean Scores for Selected Formative Assessments*

Formative Assessment	Crosscutting Concept Mean Score	Science and Engineering Practice Mean Score
Homologous Structures	0.83 (41.5%)	0.05 (2.5%)
Pedigree Chart	1.32 (66%)	1.30 (65%)

Results of formative assessments were also analyzed for common themes.

Piecharts in Figure 8 illustrate the number of crosscutting concepts described in an early formative assessment, Homologous Structures, compared to the last formative assessment, Pedigree Charts. In the Homologous Structure formative assessment, only one student completed any science and engineering practices, so that dimension was not displayed for comparison.

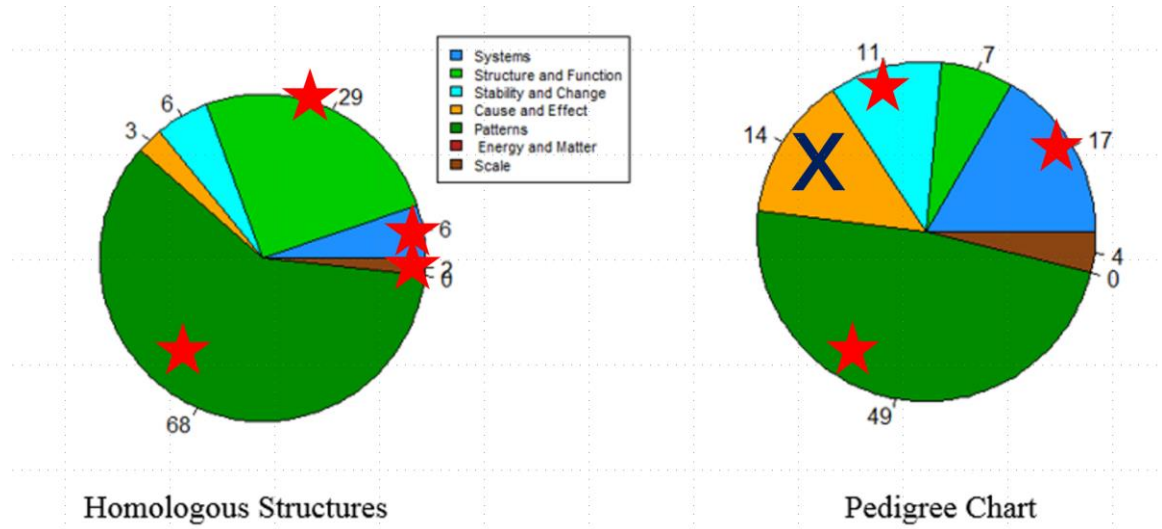

Figure 8. Crosscutting concept choices for formative assessments, Homologous Structures, (N= 73), Pedigree Chart (N=75). ★ = Appropriate Choice  
 X = Inappropriate choice

For the first formative assessment, Homologous Structures, the most appropriate choices were patterns (61.3%), structure and function (26.1%), systems (5.4%) and scale

(1.8%). No students listed three or more, and thirteen students left that question blank on the assessment. The Pedigree Chart formative assessment results shows a wider variety of responses. Patterns was the most suitable choice for an answer along with systems, and stability and change. Students chose patterns 48% of the time, and systems 16.7% of the time. In the Pedigree Chart formative assessment, student responses were more widely divided between the crosscutting concepts. In addition to the 48% choice of patterns, students listed three other concepts more than 10% of the time. Those crosscutting concepts are cause and effect (13.7%), stability and change (10.8%), and systems (16.7%).

#### INTERPRETATION AND CONCLUSION

Analysis of the results of the CTSR test found a p-value above the  $\alpha$  level of 0.05, which would indicate no support for difference between the pre- and post-treatment tests. The normalized gain was also a negative value. It was encouraging to note that the CTSR post-treatment median was higher than the pre-treatment median and that the range was also higher and narrower. Data from the unit tests also did not indicate support for a significant difference between pre-treatment achievement (Chem I) and the treatment achievement scores, as the p-values for those tests were all above the  $\alpha$  level of 0.05, and the normalized gain score was -0.63. There are some other points of interest in the comparison of the Chem I posttest scores with the treatment unit posttest scores. The median for the treatment posttest was slightly higher and the standard deviation was also greater. The bottom quartile was lower and there was a much lower bottom outlier. This meshes with teacher notes that during the treatment period discussing an increase in the

number of students struggling for various reasons (attendance, family issues, lack of academic motivation).

It was also gratifying to see that scores on all three components of the CER paragraph showed significant improvement. Student ability to write a complete claim improved by 21%, while a thorough presentation of evidence increased by 10%, and reasoning improved by 13%.

Students had more difficulty incorporating the SEP and CC concepts into the CER paragraph. I tried having them use notes from their notebooks with minimal success. We then tried sentence stems as practice, and working on a CER in table groups. We did a gallery walk in the hall and looked at group CER's to find models to use, and I gave an example of a re-written paragraph. The final CER paragraph, shortly after the treatment period ended showed notable improvement. While neither of the claims written by the previously mentioned student were perfect, the second paragraph showed clear improvement in use of language. He showed more complete phrasing than his previous claim and included the dimension of patterns in his statement. Many other students showed similar improvements, using specific language such as "this is an example of patterns," as well as being able to identify a much wider variety of appropriate crosscutting concepts and science and engineering practices. Students regularly used the word "evidence" as part of their phrasing as they included examples to support their reasoning. Part of this growth may have been due to maturity, and part may have been due to their English instruction; but part of this growth may be attributed to their exposure to the dimensions and vocabulary of the NGSS as well.

Eight formative assessments were designed and given during the treatment period. Two of them were selected for in depth analysis. The first one, Homologous Structures was given the second week of the treatment period, while the other was administered at the end of the treatment period. When I started the series of lessons on SEP's and CC's, students had a difficult time; it was right after Winter break, and many students had difficulty getting started again. We had three weeks of constant snow, but no days off or late starts. Many students were absent due to weather, and some students had significant home problems. Some students complained, "I am confused! It seems like we are doing two units and expected to learn two different kinds of things at once!" Another student asked, "Why are we doing this now? We should have done this at the beginning of the year." It seemed most appropriate to not choose the first formative assessment for further analysis. The final formative assessment was chosen for comparison. It took almost six weeks to fit in all the instructional activities on the SEP's and CC's. Students were not familiar with the dimensions of the NGSS, so it is not surprising that they would show growth in their ability to use the associated vocabulary.

It can be seen from looking at Figure 8 that by the end of the study, students still had a favorite crosscutting concept (patterns), but were able to use a much wider variety in their responses. This is confirmed by the increase in SEP and CC scores from the CER paragraphs, showing a 285% increase in the mean score, as well as the mean rating on the CC and SEP rubric from formative assessments. Students were generally appropriate in their choice of CCs and SEPs, although once in a while there would be someone who just copied them all out of their notebook, or who did not follow directions and include any.

Thorough completion of assignments is an area where my students and I generally struggle. Most students felt that if they had anything on the paper, they should get full credit. Therefore they stop as soon as they have written down one CC or SEP. When I asked them orally, they would agree that there may be two more that should have been included, but they “didn’t feel like writing.” In the future, I would re-design the formative assessments to have some kind of checklist so the barrier of student effort and writing could be removed, and I would have increased confidence that students had actually listed all concepts they felt were appropriate.

A clear goal of the NGSS is for students to be able to use SEPs and CCs. Through the work completed in this study, students showed improvement in their ability to analyze data, use models, ask questions, communicate, and support their arguments with evidence. They were able to articulate examples of systems, scale, patterns, cause and effect, stability and change, and energy and matter. Clearly, their comfort with the NGSS dimensions, and their use of NGSS vocabulary improved. When asked about the value of learning how to use the vocabulary of SEP’s and CC’s to them individually, students were generally positive. Overall, students felt that it helped them learn better; “it gave them a better idea of how a scientist would act,” “to connect things/ideas more completely,” or “how to better analyze a topic.” Many students also commented they felt their writing improved, and said they had a bigger, more varied and more precise vocabulary. Some students felt the method of learning SEPs and CCs did not make sense, or was rushed.

## VALUE

Completion of this action-based classroom research project provided me with several areas of future growth. I enjoyed creating the formative assessments, and it was useful to have immediate feedback on student progress. Unfortunately, I got bogged down on scoring both the formative assessments and CER paragraphs. Students made more effective change when they received more immediate feedback. I need to work to refine my design of activities with scoring also in mind, so that I can be timely in finishing scoring of papers.

I also need to continue to find more productive ways for students to share work and work together. Some of the best “AHA!” moments came when students worked together to create a group CER and then we did a “Hall Walk” to look at everyone’s posters.

Traditionally science teachers seem to begin the year with a unit on Nature of Science. Our team at Twin Falls has been no exception. I would like to revamp that for next year to make crosscutting concepts and science and engineering practices more of the focus; although I also need to be mindful of how to sprinkle them into the curriculum. During the treatment period, instruction was by default crammed into a very short time period. Students looked at the SEPs, and for the most part said, “Yep, we do this.” They were truly interested and engaged when I introduced the crosscutting concepts, and explained that we would be working to develop more complex thinking and reasoning skills. I wonder if some of the SEPs and CCs the students did not seem to recognize very often were partly because I was not very clear at introducing those. Students seemed to



identify more with the crosscutting concepts, which were introduced through activities, more than the science and engineering practices which were explained through videos. I will work to find and refine science and engineering activities for next year.

In light of the adoption of the NGSS by our district, and the coming changes to our standardized testing, it was interesting to try and develop something that would measure student thinking. I will use and appreciate new materials as they become more available, and look forward to working with my department to develop better assessments, and lessons.

After one year in middle school, I feel like I am still adjusting to the middle school world. I kept being told that the group of students I have this year is an exceptional group. My experience at this point is that many students were not very good at self-assessment. Students would say, "I am very confident," that they could do something; but I would find that was incorrect; or they would say that they understand everything, but fail the unit test. They would say that all their work is done, and have several missing assignments. This caused me to not give much credence to the NGSS attitude surveys.

I found as the treatment unit progressed, identifying CCs and SEPs became much more automatic for me; I found that I would stop mid-sentence and say something like, "By the way, I am expecting you to use this model to analyze and report data." Students seem to focus just a bit more with that refinement in direction-giving. I look forward to getting better at that next year! Completing this project has improved my teaching and planning for teaching. I am far more conscious of what my goals are, and how I am

going to measure if my students reach them in a timely manner. I am constantly thinking of variables that are impacting my students, such as all sections of a class getting the same information, and the same learning conditions. When scores on an assessment are different, I now have the tools to ask myself if the difference is significant, and accounted for in some way.

I am excited by results of this project because I feel the time I took to teach students the basics of crosscutting concepts and science and engineering practices allowed many of them to be more precise in their reasoning and argumentation skills. That skill is something they will be able to use no matter what path they choose in the future.

REFERENCES CITED

- Activation Lab. (March, 2016). Scientific Sensemaking Survey. Retrieved from <http://www.activationlab.org/wp-content/uploads/2016/03/Sensemaking-Report-3.2-20160331.pdf>
- Anderson, P., (2017, May 1). Bozeman Science NGSS Science Videos. Retrieved from: <http://www.bozemanscience.com/next-generation-science-standards/>
- Angelo, T. A. & Cross, K. P., (1993). *Classroom Assessment Techniques*. San Francisco: Jossey-Bass.
- Black, P. J., and Wiliam, D. (1998). Inside the Black Box: Raising Standards through Classroom Assessment. *Phi Delta Kappan*. 80, 139-148.
- Bybee, R. W., and Fuchs, B., (2006). Preparing the 21<sup>st</sup> Century Workforce: A New Reform in Science and Technology Education. *Journal of Research in Science Teaching*, 43, 349-352.
- Cafarella, J., (2015, January). Research Brief: Designing an Assessment System that Measures Three-Dimensional Science Learning. *STEMteachingtools*. Retrieved November 12, 2016, from <http://stemteachingtools.org/brief/34>
- Christmann, E. P., (2012). *Beyond the Numbers: Making Sense of Statistics*. Arlington: NSTA Press.
- Desilver, Drew, (2015, February 2). U. S. students improving – slowly- in math and science, but still lagging internationally. Retrieved November 12, 2016, from <http://www.pewresearch.org/fact-tank/2015/02/02/u-s-students-improving-slowly-in-math-and-science-but-still-lagging-internationally/>
- District Overview (2016). Snoqualmie Valley School District. Retrieved November 27, 2016 from <http://www.svsd410.org/domain/56>.
- Dozier, S. (2015, April 1). Strategies for Assessing Student Understanding in the NGSS Classroom. *California Classroom Science*. Retrieved November 12, 2016, from <http://www.classroomscience.org/strategies-for-assessing-student-understanding-in-the-ngss-classroom>
- Furtak, E., Pasquale, M., Aazzerah, R. (2016). How Teachers Can Develop Formative Assessments That Fit a Three-Dimensional View of Science Learning. *STEMteaching Tools.org*. Retrieved November 12, 2016, from <http://stemteachingtools.org/brief/18>

- Hake, R.R., (1998). Interactive-engagement versus traditional methods: A six-thousand-student survey of mechanics test data for introductory physics courses. *American Journal of Physics*. 66(1):64.
- Heritage, Margaret (2010). Formative Assessment and Next Generation Assessment Systems: Are We Losing an Opportunity? Washington D. C., Council of Chief State School Officers. Retrieved November 27, 2016, from [https://www.edpolicyinca.org/sites/default/files/Formative\\_Assessment\\_Next\\_Generation\\_2010.pdf](https://www.edpolicyinca.org/sites/default/files/Formative_Assessment_Next_Generation_2010.pdf).
- High School Feedback Reports (2014). State of Washington Education Research and Data Center. Retrieved November 27, 2016, from <http://erdcdata.wa.gov/hsfb.aspx>.
- Lawson, Anton E. (2000). Classroom Test of Scientific Reasoning, revised edition. Arizona State University. Retrieved November 27, 2016, from <http://www.public.asu.edu/~anton1/AssessArticles/Assessments/Mathematics%20Assessments/Scientific%20Reasoning%20Test.pdf>
- Lloyd, Amber L., (2016). *Assessing the Next Generation Science Standards and its effects on student and teacher learning*. (Unpublished professional paper). Montana State University, Bozeman, Montana.
- McManus, Sarah (2008). Attributes of Effective Formative Assessment. Washington, D. C., Council of Chief State School Officers. Retrieved November 27, 2016, from [http://www.ccsso.org/Resources/Publications/Attributes\\_of\\_Effective\\_Formative\\_Assessment.html](http://www.ccsso.org/Resources/Publications/Attributes_of_Effective_Formative_Assessment.html)
- Moulding, B. D., Bybee, R. W., Paulson, N. (2015) *A Vision for Science Teaching and Learning: An Educator's Guide to a Framework for K-12 Science Education, Next Generation Science Standards, and State Science Standards*. Essential Teaching and Learning.
- NGSS Lead States. (2013). Next Generation Science Standards: For states, by states. Washington, DC: National Academies Press.
- National Research Council (2007). *Taking Science to School: Learning and Teaching Science in grades K-8*. Washington, D. C.: National Academies Press.
- National Research Council (2012). *A Framework for K-12 Science Education: Practices, Crosscutting Concepts, and Core Ideas*. Washington, D. C.: National Academies Press.
- National Research Council. (2014). *Developing Assessments for the Next Generation Science Standards*. Committee on Developing Assessments of Science

Proficiency in K-12. Board on Testing and Assessment and Board on Science Education, J.W. Pellegrino, M.R. Wilson, J.A. Koenig, and A.S. Beatty, *Editors*. Division of Behavioral and Social Sciences and Education. Washington, DC: National Academies Press.

OSPI Washington State Report Card. (n.d.) Retrieved November 27, 2016, from <http://reportcard.ospi.k12.wa.us/Summary.aspx?groupLevel=District&schoolId=113&reportLevel=District&year=2008-09>

Stage, E. K., Asturias, H., Cheuk, T., Daro, P. A., Hampton, S. B. (2013, April 19). Opportunities and Challenges in Next Generation Standards. *Science*. Retrieved November 27, 2016, from <http://science.sciencemag.org/content/340/6130/276>

Trends in International Mathematics and Science Study National Center Education Statistics. Retrieved November 27, 2016, from [https://nces.ed.gov/TIMSS/results11\\_science11.asp](https://nces.ed.gov/TIMSS/results11_science11.asp)

TFMS School Improvement Plan (n.d.). Retrieved November 27, 2016, from <http://svsd.schoolwires.net/cms/lib05/WA01919490/Centricity/Domain/958//2015%20SIP.pdf>

TFMS School Profile. (n.d.) Retrieved November 27, 2016, from <http://www.svsd410.org/twinfalls>

Underwood, Molly R. (2012). *Assessing Assessment: The Impact of Formative Assessment Training on Science Teacher Classroom Methods*. (Unpublished professional paper). Montana State University, Bozeman, Montana.

APPENDICES

APPENDIX A  
CROSSCUTTING CONCEPT POSTERS



### Energy and Matter

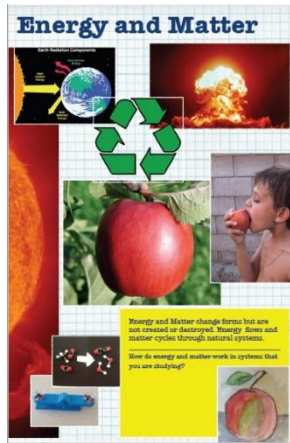

Energy and Matter change forms but are not created or destroyed. Energy flows and matter cycles through natural systems.

How do energy and matter work in systems that you are studying?

This collage includes a recycling symbol, a globe, a fire, a red apple, a child eating an apple, a planet, and a small insect.

### Cause and Effect



When we do science we try to find out the reasons why things happen.

What causes have you identified? What effects do they produce? What is your evidence?

This collage features a baseball player, a line graph, a microscope, a test tube, and a baseball bat.

### Patterns

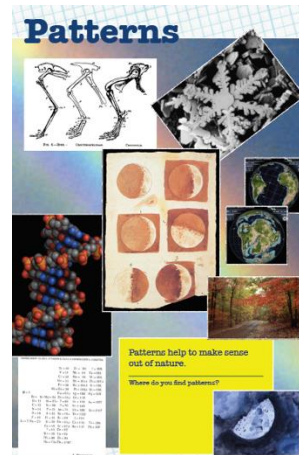

Patterns help to make sense out of nature.

Where do you find patterns?

This collage shows various patterns including a human skeleton, a moon phase chart, a globe, a molecular model, and a list of items.

### Scale

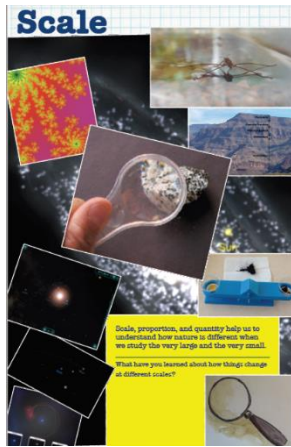

Scale, proportion, and quantity help us to understand how nature is different when we study the very large and the very small.

What have you learned about how things change at different scales?

This collage includes a hand holding a small object, a magnifying glass, a globe, and various microscopic and macroscopic images.

### Stability and Change

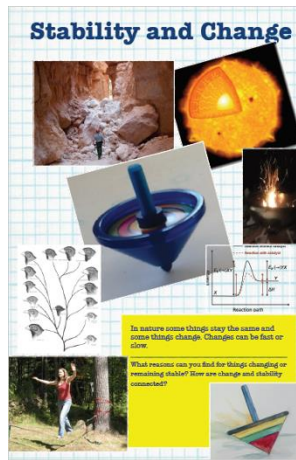

In nature some things stay the same and some things change. Changes can be fast or slow.

What reasons can you find for things changing or remaining stable? How are change and stability connected?

This collage features a blue funnel, a globe, a tree diagram, a person walking, and a boat.

### Structure and Function

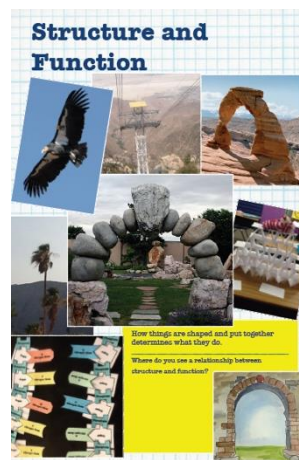

How things are shaped and put together determines what they do.

Where do you see a relationship between structure and function?

This collage shows an eagle, a stone archway, a stone bridge, and various other structures.

### Systems



Nature is complex and confusing. Thinking about systems and making system models can help you to make sense of it.

What systems can you identify and study? How do they connect to other systems?

This collage includes a ladybug, a globe, a person, and various other system components.

APPENDIX B

SCIENCE AND ENGINEERING PRACTICES POSTER

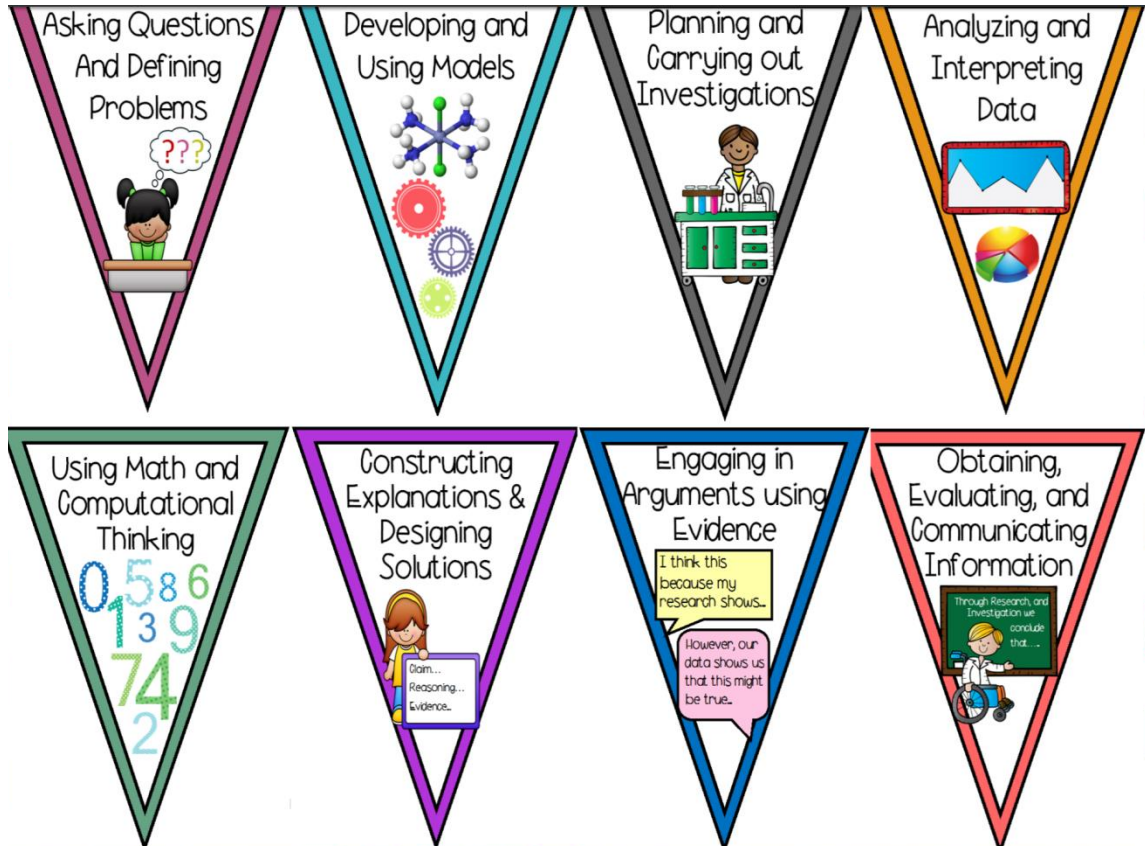

Used by permission, Teachers Pay Teachers.

APPENDIX C  
INSTITUTIONAL REVIEW BOARD APPROVAL



**INSTITUTIONAL REVIEW BOARD**  
**For the Protection of Human Subjects**  
**FWA 00000165**

960 Technology Blvd. Room 127  
 c/o Microbiology & Immunology  
 Montana State University  
 Bozeman, MT 59718  
 Telephone: 406-994-6783  
 FAX: 406-994-4303  
 E-mail: cherylj@montana.edu

*Chair:* Mark Quinn  
 406-994-4707  
 mquinn@montana.edu  
*Administrator:*  
 Cheryl Johnson  
 406-994-4706  
 cherylj@montana.edu

**MEMORANDUM**

**TO:** Lori Stanton and John Graves  
**FROM:** Mark Quinn *Mark Quinn cyj*  
**DATE:** November 21, 2016  
**SUBJECT:** "The Effects of 3D Formative Assessment in the Classroom" [LS112116-EX]

The above research, described in your submission of November 21, 2016, is exempt from the requirement of review by the Institutional Review Board in accordance with the Code of Federal regulations, Part 46, section 101. The specific paragraph which applies to your research is:

- (b) (1) Research conducted in established or commonly accepted educational settings, involving normal educational practices such as (i) research on regular and special education instructional strategies, or (ii) research on the effectiveness of or the comparison among instructional techniques, curricula, or classroom management methods.
- (b) (2) Research involving the use of educational tests (cognitive, diagnostic, aptitude, achievement), survey procedures, interview procedures or observation of public behavior, unless: (i) information obtained is recorded in such a manner that human subjects can be identified, directly or through identifiers linked to the subjects; and (ii) any disclosure of the human subjects' responses outside the research could reasonably place the subjects at risk of criminal or civil liability, or be damaging to the subjects' financial standing, employability, or reputation.
- (b) (3) Research involving the use of educational tests (cognitive, diagnostic, aptitude, achievement), survey procedures, interview procedures, or observation of public behavior that is not exempt under paragraph (b)(2) of this section, if: (i) the human subjects are elected or appointed public officials or candidates for public office; or (ii) federal statute(s) without exception that the confidentiality of the personally identifiable information will be maintained throughout the research and thereafter.
- (b) (4) Research involving the collection or study of existing data, documents, records, pathological specimens, or diagnostic specimens, if these sources are publicly available, or if the information is recorded by the investigator in such a manner that the subjects cannot be identified, directly or through identifiers linked to the subjects.
- (b) (5) Research and demonstration projects, which are conducted by or subject to the approval of department or agency heads, and which are designed to study, evaluate, or otherwise examine: (i) public benefit or service programs; (ii) procedures for obtaining benefits or services under those programs; (iii) possible changes in or alternatives to those programs or procedures; or (iv) possible changes in methods or levels of payment for benefits or services under those programs.
- (b) (6) Taste and food quality evaluation and consumer acceptance studies, (i) if wholesome foods without additives are consumed, or (ii) if a food is consumed that contains a food ingredient at or below the level and for a use found to be safe, or agricultural chemical or environmental contaminant at or below the level found to be safe, by the FDA, or approved by the EPA, or the Food Safety and Inspection Service of the USDA.

Although review by the Institutional Review Board is not required for the above research, the Committee will be glad to review it. If you wish a review and committee approval, please submit 3 copies of the usual application form and it will be processed by expedited review.

APPENDIX D

MODIFIED CLASSROOM TEST OF SCIENTIFIC REASONING



This is a test of your ability to apply scientific and mathematical reasoning to solve a situation or make a prediction. If you do not fully understand a question, you may ask for clarification. Participation in this test will not affect your grade or standing in class in any way.

1. Suppose you are given two clay balls of equal size and shape. The two clay balls also have the same mass. One ball is flattened into a pancake-shaped piece. Which of these statements is correct?
  - a. The pancake-shaped piece has more mass than the ball.
  - b. The two pieces still have the same mass.
  - c. The mass of the ball is more than the pancake-shaped piece.
2. ....because
  - a. The flattened piece covers a larger area.
  - b. The ball pushed down more on one spot.
  - c. When something is flattened it loses weight.
  - d. Clay has not been added or taken away.
  - e. When something is flattened it gains weight.
3. To the right are drawings of two cylinders filled to the same level with water. The cylinders are identical in size and shape. To a

Also shown at the right are two marbles, one glass and one steel. The marbles are the same size but the steel one is much heavier than the glass one.

When the glass marble is put into Cylinder 1 it sinks to the bottom and the water level rises to the 6<sup>th</sup> mark. If we put the same steel marble into Cylinder 2, the water will rise

- a. To the same level it did in Cylinder 1
  - b. To a higher level than it did in Cylinder 1
  - c. To a lower level than it did in Cylinder 1
4. ....because
    - a. The steel marble will sink faster.
    - b. The marbles are made of different materials
    - c. The steel marble is heavier than the glass marble
    - d. The marbles are the same size.

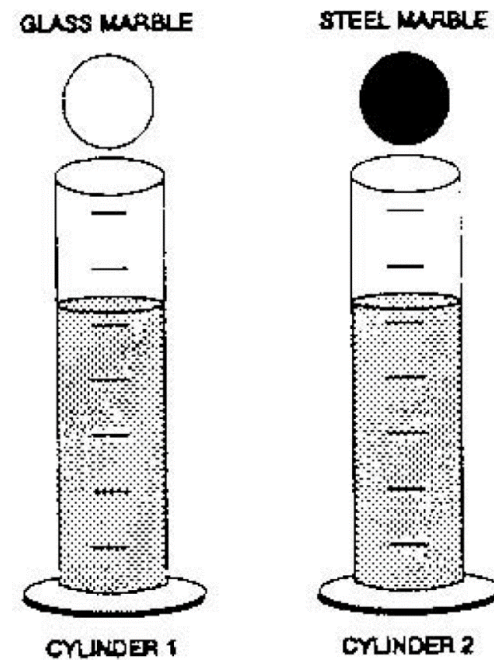

5. To the right are drawings of a wide and narrow cylinder. The cylinders have equally spaced marks on them. Water is poured into the wide cylinder up to the 4<sup>th</sup> mark. (see A). This water is then poured into the narrow cylinder and rises up to the 6<sup>th</sup> mark.

Both cylinders are then emptied (not shown) and water is poured into the wide cylinder up to the 6<sup>th</sup> mark. *How high would this water rise if it were poured into the empty narrow cylinder?*

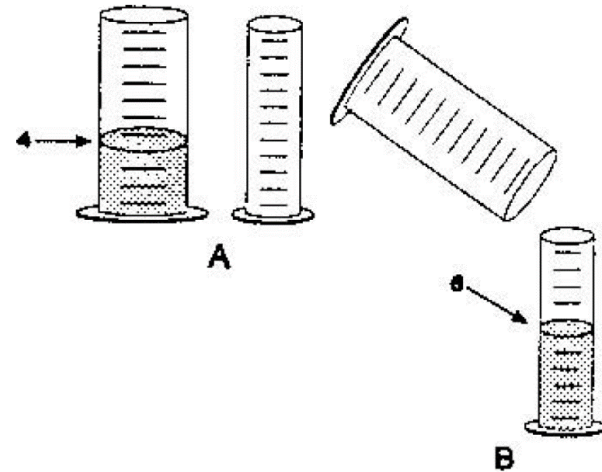

- a. To about 8  
 b. To about 9  
 c. To about 10  
 d. To about 12  
 e. None of these answers is correct
6. ....because
- a. The answer cannot be determined with the information given.  
 b. It went up 2 more before, so it will go up 2 again.  
 c. It goes up 3 in the narrow for every 2 in the wide.  
 d. The second cylinder is narrower  
 e. One must actually pour the water and observe to find out.



7. At the right are drawings of three strings hanging from a bar. The three strings have metal weights attached to their ends. String 1 and string 3 are the same length. String 2 is shorter. A 10 unit weight is attached to the ends of strings 1 and 2. A 5 unit weight is attached to the end of string 3. The strings (and attached weights) can be swung back and forth and the time it takes to make a swing can be timed.

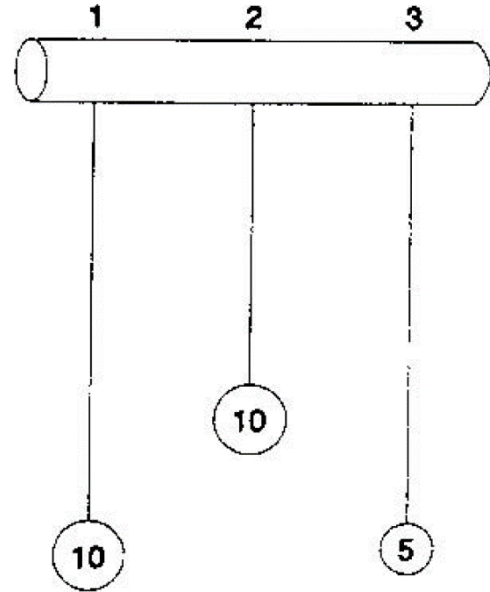

Suppose you want to find out whether the Length of the string has an effect on the time it Takes to complete one swing back and forth.

Which strings would you use to find out?

- a. Only one string
  - b. All three strings
  - c. Strings 2 and 3
  - d. Strings 1 and 3
  - e. Strings 1 and 2
8. ....because
- a. You must use the longest strings
  - b. You must compare strings with both light and heavy weights
  - c. Only the lengths differ
  - d. To make all possible comparisons
  - e. The weights differ
9. Twenty fruit flies are placed in each of four glass tubes. The tubes are sealed and the flies spread out evenly within the tubes. Tubes I and II are partially covered with black paper (as shown). Tubes III and IV are not covered. The tubes are placed as shown, some upright, and some laying down. Then they are exposed to red light for five minutes. The number of flies in the uncovered part of each tube is shown in the drawing.

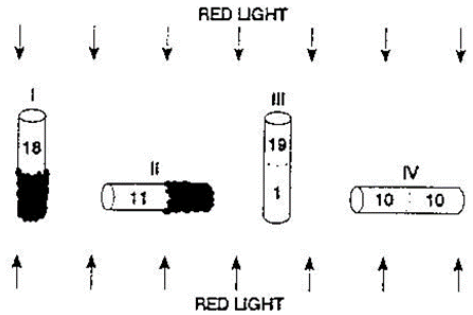

The experiment shows that flies .....

- a. Respond by moving to or away from Red light but do not respond to gravity
- b. Respond by moving to or away from gravity but do not respond to red light
- c. Respond by moving to or away from both red light and gravity
- d. Do not respond to either red light or gravity

10 .....because

- Most flies are the top of Tube III but spread out evenly in Tube II
- Most flies did not go to the bottom of tubes I and III
- The flies need light to see and must fly against gravity
- The majority of flies are in the upper ends and the lighted ends of the tubes
- Some flies are in both ends of each tube.

11. Six square pieces of wood are put into a cloth bag and mixed About. The six pieces are identical in size and shape, however, Three pieces are red and three are yellow. Suppose someone Reaches into the bag (without looking) and pulls out one piece. *What are the chances the pieces are read?*

- 1 chance out of 6
- 1 chance out of 3
- 1 chance out of 2
- 1 chance out of 1
- Cannot be determined

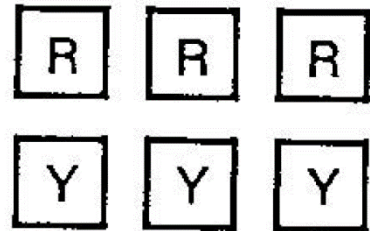

12. ....because

- 3 out of the 6 pieces are red
- There is no way to tell which piece will be picked
- Only 1 piece out of the 6 in the bag is picked
- All 6 pieces are identical in size and shape
- Only 1 red piece can be picked out of the 3 red pieces

13. Farmer Brown was observing the mice that lived in his field. He discovered that all of them with either fat or thin. Also, all of them had either black tails or white tails. This made him wonder if there might be a link between the size of the mice and the color of their tails. So he captured all of the mice in one section of his field and observed them. Below are the mice he captured.

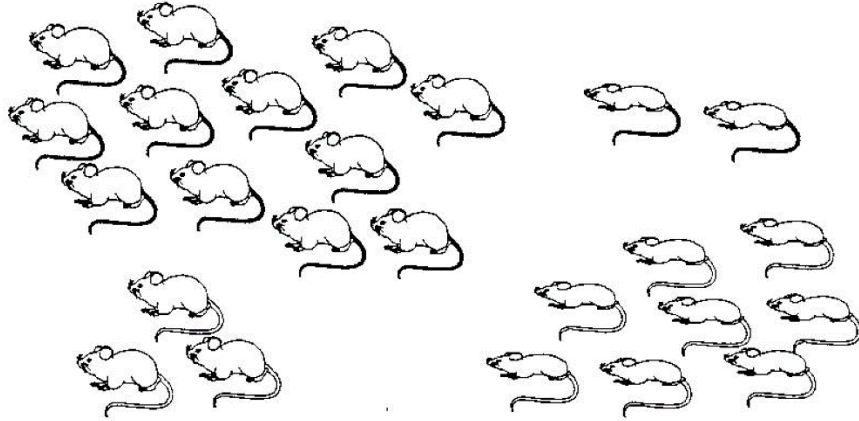

*Do you think there is a link between the size of the mice and the color of their tails?*

- a. There appears to be a link
  - b. There appears to be NO link
  - c. Cannot make a reasonable guess
14. ....*because*
- a. There may some of each kind of mouse
  - b. There may be a genetic link between mouse size and tail color
  - c. There were not enough mice captured
  - d. Most of the mice have black tails while most of the thin mice have white tails.
  - e. As the mice grew fatter, their tails became darker

APPENDIX E  
FULL OPTION SCIENCE SYSTEM (FOSS)  
CHEMICAL INTERACTIONS UNIT TEST

Name \_\_\_\_\_ period \_\_\_\_\_ 14-15 2016

Please be sure to read each question carefully and look at all your choices for answers before selecting one. Don't forget to include explanations when asked!

1. A student put room-temperature water into a bottle. She pushed a stopper and tube into the bottle until the water came half way up the tube. The student turned the bottle system sideways and put a cold wrap around the bottle for 2 minutes. She then put a hot wrap around the bottle.

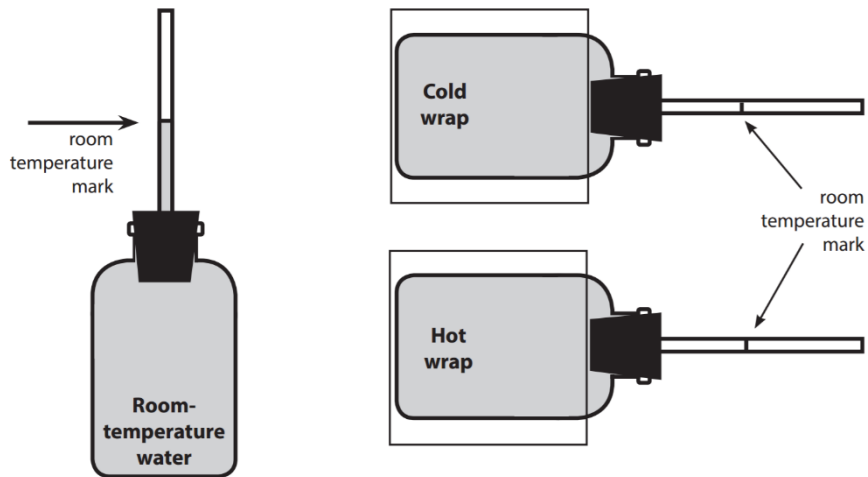

- a. Draw a water level line in the tube for the cold wrap tube and for the tube connected to the hot wrap.
- b. What happened to the kinetic energy of the water particles when the student put the hot wrap on the cold bottle? (*Mark the one best answer.*)
  - The kinetic energy of the water particles increased.
  - The kinetic energy of the water particles decreased.
  - There was no change in the kinetic energy of the water particles.
- c. What cause the water level in the tube to change when the student put the hot wrap on the bottle?

2. An aluminum nut and bolt are stuck together.  
 a. To get them apart, would you put ice on the nut or on the bolt?  
 (*Mark one best answer.*)

- The nut  
 The bolt

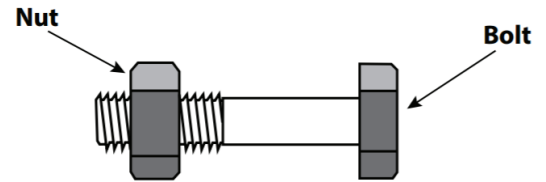

- b. Why did you choose that answer?
- c. What role does kinetic energy play in getting the nut and bolt apart?

3. What happens to the particles in a cup of cold juice as it warms up to room temperature?  
 (*Mark the one best answer.*)

- The number of juice particles decreases.  
 The size of juice particles increases.  
 The motion of the juice particles decreases.  
 The space between the juice particles increases.

4. A student put a cap on a bottle, trapping room temperature air inside. He put the bottle in the freezer for 15 minutes, then took it out and saw that the bottle looked different. What caused the bottle to change shape?  
 (*Mark the one best answer.*)

- Some of the air particles got out of the bottle.  
 The air particles got closer together.  
 The air particles settled to the bottom of the bottle.

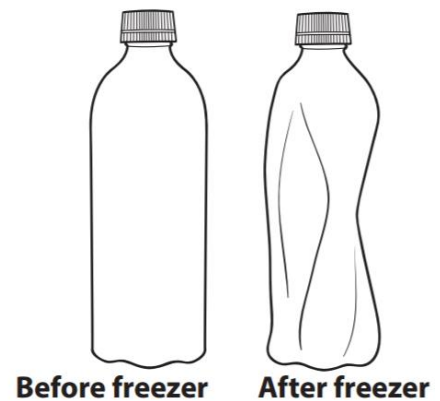

The air particles cooled and became smaller.

5. When a piece of solid lead is heated (but not melted), the lead particles

\_\_\_\_\_.

*(Mark ALL that apply.)*

\_\_\_\_\_ move slower

\_\_\_\_\_ get farther apart

\_\_\_\_\_ have fewer collisions

\_\_\_\_\_ get closer together

\_\_\_\_\_ bump into each other more

6. a. What is the difference between compression and contraction?

b. Give an example of compression.

c. Give an example of contraction.

7. In what phase of matter are the particles spaced the farthest apart?

*(Mark the one best answer.)*

A gas

A liquid

A solid

All are equal

8. A jeweler heats a silver strip and bends it into a bracelet. The bracelet cools down when the jeweler is finished. What happens to the kinetic energy of the silver particles as the solid silver cools? The kinetic energy of the particles \_\_\_\_\_ . (Mark the one best answer.)

- Increases
- Decreases, until the particles stop moving
- Decreases, but the particles still move
- Does not change

9. A student put a vial of plain water into a container of ice. She put the container into a freezer. The starting temperatures are listed below.

Water in the vial:  $22^{\circ}\text{C}$

Ice :  $0^{\circ}\text{C}$

Freezer environment:  $-17^{\circ}\text{C}$

In the diagram, draw arrows in the blank boxes to show the direction of the energy transfer between

- The freezer and the ice (X)
- The freezer and the water in the vial (Y)
- The ice and the water in the vial (Z)

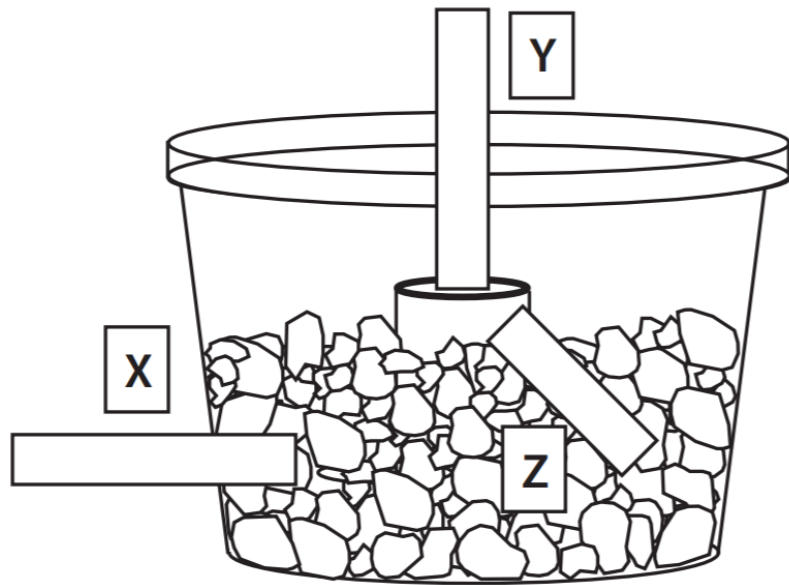

10. A closed container of water is kept at a constant temperature. Which of the following statements about the water particles is true? (Mark the one best answer.)

- The average kinetic energy of the water particles is the same.
- The average kinetic energy of the water particles increases a little bit.
- The average kinetic energy of the water particles decreases a little bit.



- The water particles stop moving.

11. A plastic water bottle filled with warm air is placed into cold water.

The temperature of the air gets \_\_\_\_\_.

The temperature of the water gets \_\_\_\_\_.

Describe the energy transfer between the air particles and the water particles.

12. What happens when cold milk is poured into hot chocolate?

*(Mark an X next to all correct answers.)*

\_\_\_\_\_ Energy flows from the milk to the chocolate.

\_\_\_\_\_ Energy flows from the chocolate to the milk.

\_\_\_\_\_ The kinetic energy of the milk increases.

\_\_\_\_\_ The kinetic energy of the chocolate increases.

13. A fast-moving particle (A) and a slow-moving particle (B) collide.

a. Which particle has more kinetic energy before the collision?

(Mark the one best answer.)

- Particle A
  - Particle B
  - A and B have the same kinetic energy
- b. What happens to the kinetic energy when the particles collide?
- Energy transfers to particle A
  - Energy transfers to particle B
  - Energy transfers to both particles
- c. Describe the change in speed of each particle after the collision.  
 Particle A-  
 Particle B-
14. A baker has two identical cakes except that one cake is hot, and the other cake is room temperature. He places both cakes on a cold plate. What happens?  
 (Mark the one best answer.)
- Only the hot cake transfers energy to the plate
  - The plate transfers energy to the room-temperature cake.
  - Both cakes transfer energy to the plate.
  - Neither cake transfers energy to the plate.

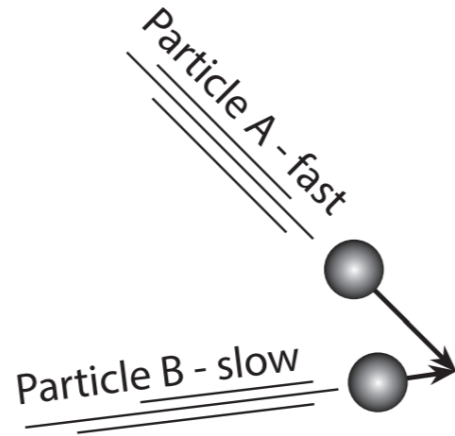

Why did you choose that answer?

15. Things heat up and cool down as a result of energy transfer. Energy flows \_\_\_\_\_.  
 (Mark the one best answer.)

- From hot to cold materials
- From cold materials to hot materials
- In both directions

- Only until equilibrium is reached

16. The iron and water in this system are at the same temperature.

a. Which particles have more average kinetic energy?  
(Mark the one best answer.)

- The water particles
- The iron particles
- They both have the same

Why did you choose that answer?

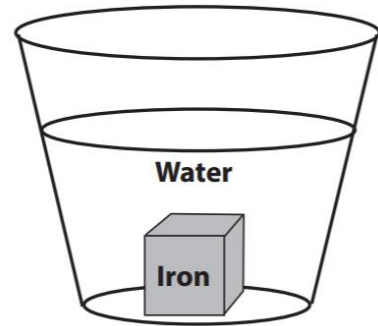

b. Describe the energy transfer between the water and the iron.

APPENDIX F  
FULL OPTION SCIENCE SYSTEM (FOSS) HEREDITY AND  
ADAPTATION PRE-TEST AND POST TEST

Name \_\_\_\_\_

Date \_\_\_\_\_ Class \_\_\_\_\_

## POSTTEST

### HEREDITY AND ADAPTATION

1. The frog and the whale are both tetrapods (vertebrates with four limbs). The adult whale does not have four limbs.

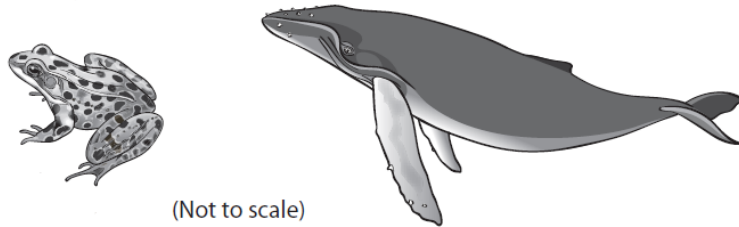

Examine the images of the whale embryo's development.

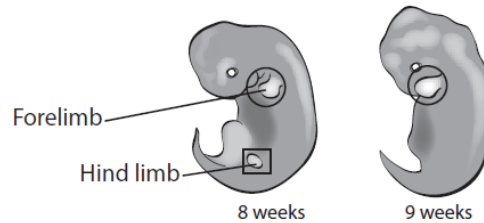

The 8-week-old whale embryo has forelimbs and hind limbs. The hind limbs disappear in later development. What information can you gain from looking at the development of an embryo?

(Mark the one best answer.)

- A** The embryo development helps identify a relationship that is not always apparent when comparing adults.
- B** The embryo shows that the adult whale will have four limbs.
- C** The whale's embryo development is most likely the same as the frog's.
- D** Embryos are important in order to compare what environment the organism lives in.

Name \_\_\_\_\_

## POSTTEST

### HEREDITY AND ADAPTATION

2. Compare the limbs of the modern vertebrates.

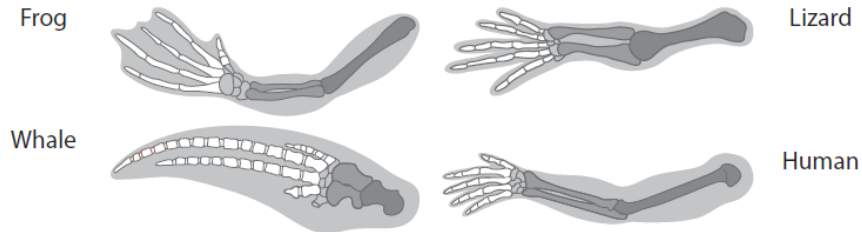

Which statement best explains the similarities between the limbs?

(Mark the one best answer.)

- A All four vertebrates move in the same way.
  - B These four vertebrates share a common ancestor.
  - C The limbs can be used in water or on land.
  - D A lizard is an ancestor of a frog.
3. Trilobite fossils have been found in rock that is 521 million years old. They have also been found in rocks that are more than 252 million years old. Trilobite fossils have not been found in younger or older rocks. What does this tell you?

(Mark the one best answer.)

- A Trilobites became extinct 252 million years ago.
- B Trilobites became extinct 521 million years ago.
- C Trilobites lived on Earth for 252 million years.
- D Trilobites lived on Earth more than 521 million years ago.

Name \_\_\_\_\_

**POSTTEST**  
**HEREDITY AND ADAPTATION**

4. Which process best explains how antibiotic resistance in bacteria can occur?

*(Mark the one best answer.)*

- A Bacteria gradually become more resistant to an antibiotic and pass on their resistance to their offspring.
- B While being treated with an antibiotic, some bacteria will become stronger and survive to pass on the resistance to their offspring.
- C A patient becomes resistant to antibiotics, depending upon the conditions of the hospital.
- D Bacteria that already have a genetic resistance to an antibiotic will survive and pass on the resistance to their offspring.

5. Explain how a mutation in an individual's DNA can become an adaptation in a population.

---



---



---



---



---

6. Mark an **X** next to each condition that is necessary for natural selection to occur within a population.

- \_\_\_\_\_ Environmental pressures must be causing some individuals to adapt and reproduce.
- \_\_\_\_\_ Several species must have recently become extinct.
- \_\_\_\_\_ Traits must be inherited.
- \_\_\_\_\_ Variation of traits must exist in the population.
- \_\_\_\_\_ Individuals with beneficial traits have more offspring than other individuals in a population.

Name \_\_\_\_\_

## POSTTEST

### HEREDITY AND ADAPTATION

7. Peppered moths live in forests in Europe. Coloring is a genetic trait. Some moths are light-colored and some are dark. Peppered moths typically live on trees covered by a light-colored lichen. Birds eat moths that they can find. Many years ago, scientists observed that smoke from factories killed the lichen on the trees and the bark appeared darker.

a. Which graph represents what happened to the number of light and dark moths as the bark became darker? (Mark the one best answer.)

A

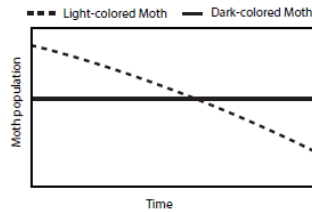

B

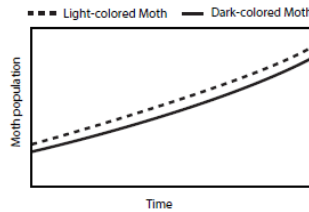

C

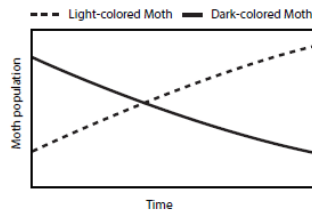

D

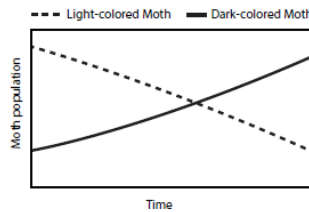

b. Which statement best explains what happened to the moth population?

(Mark the one best answer.)

- A Light-colored moths that survived did not have offspring because their offspring would have been easily seen and eaten by birds.
- B Light-colored moths that survived had dark offspring because the change in the environment caused the parents to have offspring that would do better in the new environment.
- C Dark-colored moths were less likely to be eaten, so the light-colored moths made themselves dark.
- D Dark-colored moths were less likely to be eaten, so their numbers increased.



Name \_\_\_\_\_

## POSTTEST

### HEREDITY AND ADAPTATION

8. A flowering shrub has two possible flower color traits: red and white. The dominant allele (R) codes for red flowers, the recessive allele (r) codes for white flowers. A heterozygous red-flowered shrub is cross-pollinated by a white-flowered shrub.

- a. Which Punnett square would you use to predict the probability of shrub offspring having red or white flowers?

(Mark the one best answer.)

<p><input type="radio"/> <b>A</b></p> <table style="margin-left: 40px;"> <tr> <td></td> <td style="text-align: center;">R</td> <td style="text-align: center;">r</td> </tr> <tr> <td style="text-align: center;">R</td> <td style="border: 1px solid black; width: 40px; height: 40px;"></td> <td style="border: 1px solid black; width: 40px; height: 40px;"></td> </tr> <tr> <td style="text-align: center;">R</td> <td style="border: 1px solid black; width: 40px; height: 40px;"></td> <td style="border: 1px solid black; width: 40px; height: 40px;"></td> </tr> </table>		R	r	R			R			<p><input type="radio"/> <b>B</b></p> <table style="margin-left: 40px;"> <tr> <td></td> <td style="text-align: center;">r</td> <td style="text-align: center;">r</td> </tr> <tr> <td style="text-align: center;">R</td> <td style="border: 1px solid black; width: 40px; height: 40px;"></td> <td style="border: 1px solid black; width: 40px; height: 40px;"></td> </tr> <tr> <td style="text-align: center;">r</td> <td style="border: 1px solid black; width: 40px; height: 40px;"></td> <td style="border: 1px solid black; width: 40px; height: 40px;"></td> </tr> </table>		r	r	R			r		
	R	r																	
R																			
R																			
	r	r																	
R																			
r																			
<p><input type="radio"/> <b>C</b></p> <table style="margin-left: 40px;"> <tr> <td></td> <td style="text-align: center;">R</td> <td style="text-align: center;">r</td> </tr> <tr> <td style="text-align: center;">R</td> <td style="border: 1px solid black; width: 40px; height: 40px;"></td> <td style="border: 1px solid black; width: 40px; height: 40px;"></td> </tr> <tr> <td style="text-align: center;">r</td> <td style="border: 1px solid black; width: 40px; height: 40px;"></td> <td style="border: 1px solid black; width: 40px; height: 40px;"></td> </tr> </table>		R	r	R			r			<p><input type="radio"/> <b>D</b></p> <table style="margin-left: 40px;"> <tr> <td></td> <td style="text-align: center;">R</td> <td style="text-align: center;">R</td> </tr> <tr> <td style="text-align: center;">r</td> <td style="border: 1px solid black; width: 40px; height: 40px;"></td> <td style="border: 1px solid black; width: 40px; height: 40px;"></td> </tr> <tr> <td style="text-align: center;">r</td> <td style="border: 1px solid black; width: 40px; height: 40px;"></td> <td style="border: 1px solid black; width: 40px; height: 40px;"></td> </tr> </table>		R	R	r			r		
	R	r																	
R																			
r																			
	R	R																	
r																			
r																			

- b. What is the probability that an offspring of the parent generation will have white flowers?

(Mark the one best answer.)

- A** 0%
- B** 25%
- C** 50%
- D** 100%

Name \_\_\_\_\_

## POSTTEST

### HEREDITY AND ADAPTATION

9. How can genetic variation be introduced into a population of asexual organisms such as bacteria?

(Mark the one best answer.)

- A Bacterial change and begin to reproduce sexually.
- B The environment where the bacteria lives changes so the bacteria change.
- C Mutations occur randomly in the bacterial DNA.
- D A bacteria receives genetic information from both parent cells.

10. *Aedes aegypti* mosquitoes spread deadly diseases like yellow fever, dengue, chikungunya, and Zika.

- Mosquitoes must be adults in order to reproduce.
- Only adult females bite humans. This is how they transmit diseases to people.
- People spray pesticide chemicals to kill the mosquitoes, but those chemicals can have harmful effects on humans and other organisms.
- Scientists have modified a gene that causes the offspring of a GM mosquito to die before they become adults.
- Scientists are releasing male GM mosquitoes into the wild so they can mate with wild female mosquitoes.

a. How will releasing the GM male mosquitoes reduce the mosquito population?

(Mark the one best answer.)

- A The male GM mosquitoes that are released won't reproduce.
- B The female mosquitoes that mate with the GM males won't reproduce.
- C The offspring of the GM males won't live long enough to reproduce.
- D The female mosquitoes will die when they mate with the GM males.

b. Mark an **X** next to the statements that are arguments against the release of GM mosquitoes.

\_\_\_\_\_ The modified gene could mutate once it is in the wild population.

\_\_\_\_\_ Using pesticide chemicals is a much safer treatment plan.

\_\_\_\_\_ The male GM mosquitoes could breed with wild female mosquitoes.

\_\_\_\_\_ Reducing populations of one kind of disease-carrying mosquito could allow different populations of disease-carrying mosquitos to increase.

Name \_\_\_\_\_

**POSTTEST**  
**HEREDITY AND ADAPTATION**

11. In November 2015, the US Food and Drug Administration (FDA) approved the first genetically altered animal for consumption in the United States. AquAdvantage salmon is a genetically modified (GM) Atlantic salmon that includes other fish genes. These other genes enable it to grow year-round rather than only during spring and summer. Consider the bulleted statements to answer the questions below.

- The gene modification allows AquAdvantage salmon to grow twice as fast as non-engineered farm-raised salmon.
- Some environmentalists worry if the faster growing GM salmon were to escape into the wild, they could outcompete wild Atlantic salmon and/or interbreed with the wild populations. Other scientists hope increasing farm productivity could reduce pressure of fishing on wild salmon populations.
- The FDA requires that the AquAdvantage salmon be grown in land-based systems (instead of pens floating in coastal waters) to reduce the risk of the GM salmon escaping into the wild. AquaBounty (the company that designed the GM salmon) will only sell eggs to fish farms that are female and sterile (cannot reproduce).
- The World Health Organization, American Medical Association, and the National Academy of Sciences have all determined that GMO food is not hazardous to human health.

a. Based on this information, what is the benefit of the GM salmon technology?

\_\_\_\_\_  
\_\_\_\_\_  
\_\_\_\_\_

b. Why do you think the FDA is so heavily regulating AquaBounty?

\_\_\_\_\_  
\_\_\_\_\_  
\_\_\_\_\_

c. Many large grocery chains refuse to sell AquAdvantage salmon. Why do you think they have made this decision?

\_\_\_\_\_  
\_\_\_\_\_  
\_\_\_\_\_

APPENDIX G

NGSS SEP AND CC CONFIDENCE SURVEY

This survey is to measure your confidence in understanding and using the Science and Engineering Practices and Crosscutting Concepts of the Next Generation Science Standards. Participation in this test will not affect your grade or standing in class in any way.

Choose one best answer for each row.

1. Regarding **Science Practices**, how confident are you at.....

	Not confident; I wouldn't know where to begin	Somewhat confident; I would be unsure if my answer was correct	Confident; I am pretty sure I would get this correct	Very confident; I could teach this to someone else
<b>Asking questions</b> to determine relationships between independent and dependent variables				
<b>Using and or constructing models</b> to predict, explain, and/or collect data				
Using tools and technologies to <b>generate and analyze data</b> in order to make scientific claims				
<b>Using mathematical thinking</b> to identify patterns in large data sets				
<b>Constructing explanations</b> for relationships between variables				
Comparing two <b>arguments from evidence</b> in order to identify which is better by identifying flaws in logic or methods				
<b>Obtaining, evaluating, and communicating information</b> using scientific language and reasoning				

## 2. Select the Crosscutting Concept that BEST fits the science concept.

	Patterns	Cause and Effect	Scale, Proportion, and Quantity	Systems, and System Models	Energy and Matter	Structure and Function	Stability and Change
The proportion of individual organisms that have genetic variations and traits that are advantageous in a particular environment will decrease over time as they do not survive to reproduce							
In a particular environment, some traits of an organism will give advantages that make it more probable that an organism will survive and be able to reproduce there.							
Humans can influence the inheritance of desired traits in living organisms through artificial selection by choosing desired parental traits determined by genes. These traits are then passed to succeeding offspring.							
Characteristics of a species may change over time (many generations) through adaptation by natural selection in response to changes in environmental conditions.							
In asexual reproduction, offspring have a single source of genetic information, and their chromosomes are complete copies of the parent pair of chromosomes.							
The proportion of individual organisms that have genetic variations and traits that are advantageous in a particular environment will increase from generation to generation due to natural selection as they survive and reproduce.							
Organisms that share anatomical features are likely to be more closely related than are organisms that do not share anatomical features, because of the relationship between genetic makeup and anatomy							
Changes in time in the anatomical features observed in the fossil record can be used to infer lines of evolutionary descent by linking extinct organisms to living organisms through shared sets of anatomical features.							
The similarities and changes in embryo development are evidence for relatedness among apparently diverse species.							
The fossil record documents the existence of diversity, extinction, and change of many life forms throughout the history of life on Earth.							

3. Please enter your first, middle and last initial so that I can match your pre- and post-surveys. Thank you for your thoughtfulness!

APPENDIX H

CLAIMS-EVIDENCE-REASONING PARAGRAPH



**Claim:** What do you know? What is the answer to your question? This should be one sentence.

**Evidence:** What is the data that you have collected that answers this question? What did you do? What research do you have? This should be multiple sentences.

**Reasoning:** Why does your evidence support your claim? How are they connected? This should be more than one sentence.

APPENDIX I

CLAIMS-EVIDENCE-REASONING RUBRIC

Name \_\_\_\_\_ Title \_\_\_\_\_ Date \_\_\_\_\_ Period \_\_\_\_\_

**Claims, Evidence and Reasoning**

	<b>4</b>	<b>3</b>	<b>2</b>	<b>1</b>	<b>0</b>
<b>Claim –</b>	<ul style="list-style-type: none"> <li>Scientifically accurate</li> <li>Completely answers the question</li> </ul>	<ul style="list-style-type: none"> <li>Scientifically accurate</li> <li>Nearly completely answers the question</li> </ul>	<ul style="list-style-type: none"> <li>Partially scientifically accurate</li> <li>Partially answers the question</li> </ul>	<ul style="list-style-type: none"> <li>Is not scientifically accurate overall</li> </ul>	No claim
<b>Evidence –</b> scientific data that supports the claim	<ul style="list-style-type: none"> <li>The data are scientifically appropriate to support the claim.</li> <li>The data are thorough and convincing – enough details and evidence provided.</li> </ul>	<ul style="list-style-type: none"> <li>The data are scientifically appropriate to support the claim</li> <li>The data are basically sufficient and convincing, but tend to be more general and not as specific and in depth</li> </ul>	<ul style="list-style-type: none"> <li>The data relate to the claim, but are not entirely scientifically appropriate</li> <li>The data are not sufficient, though generally support the claim</li> </ul>	<ul style="list-style-type: none"> <li>There is some evidence provided, but it is not logically linked to the claim or scientifically appropriate</li> </ul>	No evidence provided
<b>Reasoning –</b> a justification that links the claim and evidence	<ul style="list-style-type: none"> <li>Reasoning clearly links evidence to claim</li> <li>Shows why the data count as evidence by using appropriate scientific principles</li> <li>There are sufficient scientific principles to make links clear between claim and evidence</li> </ul>	<ul style="list-style-type: none"> <li>Reasoning adequately links claim to evidence</li> <li>Includes related scientific principles, but only passably clarifies why this data count as evidence</li> <li>Reasoning tends to be more general and shows only partial depth of content understanding</li> </ul>	<ul style="list-style-type: none"> <li>Reasoning does not adequately link claim to evidence, or clarify why data count as evidence</li> <li>Includes related and non-related scientific principles, and shows little depth of content understanding</li> </ul>	<ul style="list-style-type: none"> <li>Reasoning is clearly insufficient and relates only tangentially to question and claim at hand</li> <li>Scientific understanding is very limited</li> </ul>	Does not provide reasoning
		Multiple References – 2points	Mentioned Once – 1 point	No Mention – 0 points	
Crosscutting Concepts					
Science and Engineering Practice					

APPENDIX J  
FORMATIVE ASSESSMENT  
PATTERNS IN THE FOSSIL RECORD

Name \_\_\_\_\_ period \_\_\_\_\_

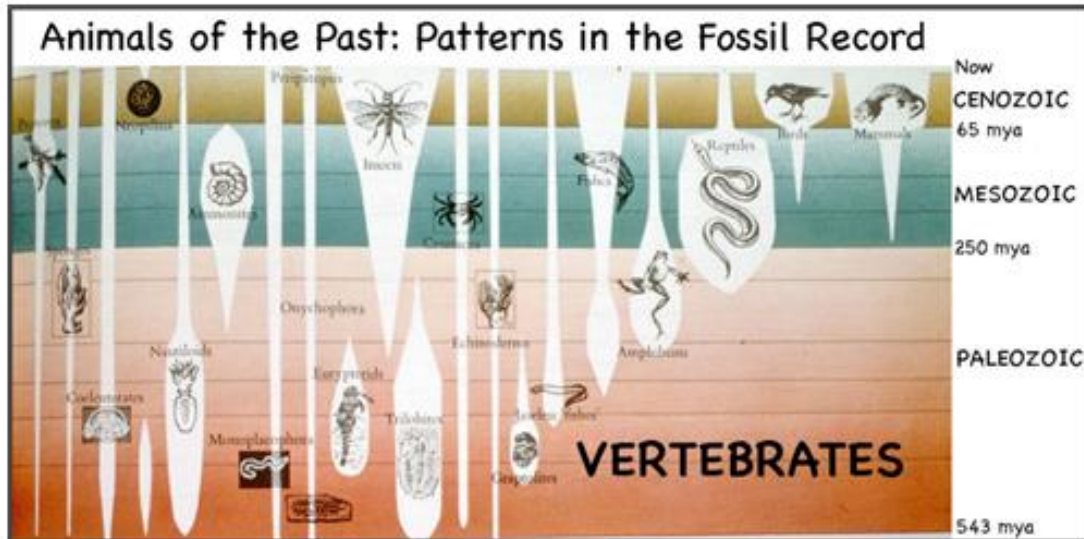

- Looking at the chart above, circle in green two organisms that lived on earth at the same time. Then put red squares around two organisms that did not live on earth at the same time.
- Explain what details in the chart above you used to make your decisions.  

---



---



---
- As you worked to complete question two above, which science and engineering practice (SEP) were you using?

- 
- Which crosscutting concepts are you exploring as you look over the details of this chart to decide how to answer number 2.

APPENDIX K  
FORMATIVE ASSESSMENT  
HOMOLOGOUS STRUCTURES

A student showed her friend some pictures that she had of the limbs of some ancient extinct organisms.

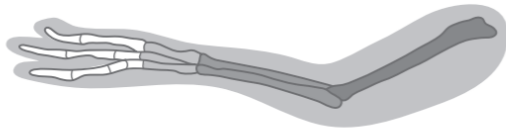

Theropod dinosaur leg

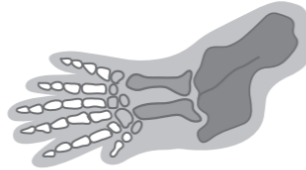

Tulerpeton leg

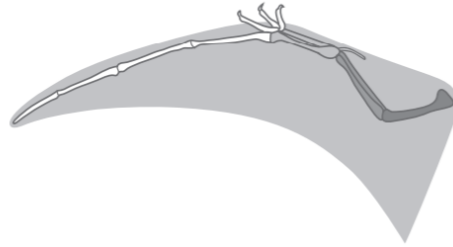

Pterosaur dinosaur wing

Her friend said, “Hey, those look like limbs I have seen from some modern organisms!” He showed her the pictures he had.



Frog arm

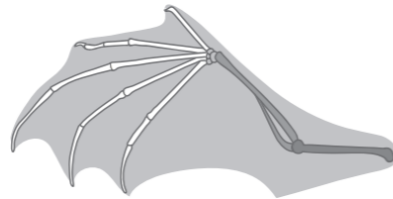

Bat wing

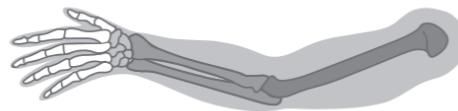

Human arm

Use what you know about limbs and homologous structures to explain the similarities.

What crosscutting concept are you using as you answer that question?

What Science and Engineering concepts are you using when you compare these images?

APPENDIX L  
FORMATIVE ASSESSMENT  
PHYLOGENETIC TREES I



Name \_\_\_\_\_ period \_\_\_\_\_



Learning Target:

Use the Cladistics chart to complete the cladogram below. Then answer the question at the bottom.

	Starfish	Frog	Monkey	Rodent	Bird
Eggs	X	X	X	X	X
Backbone		X	X	X	X
Warm-blooded			X	X	X
Hair			X	X	

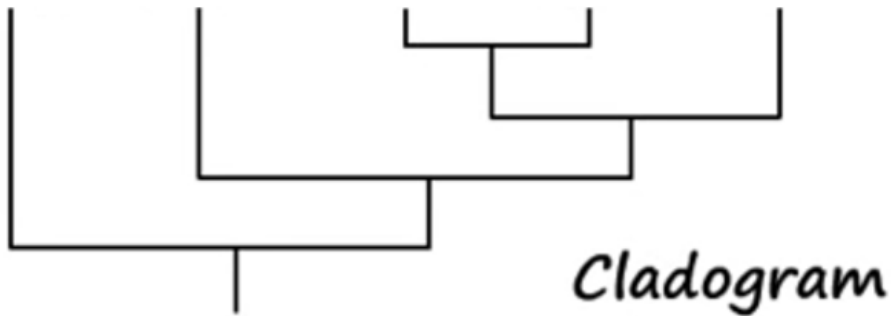

- On this chart, put a circle and number 1 where the most recent common ancestor of a rodent and bird would be.
- Which two organisms are most closely related according to this cladogram?
- What evidence or pattern did you see on this cladogram that would tell you that?
- What Crosscutting concepts did you use to answer these questions. Put all that apply!!

APPENDIX M  
FORMATIVE ASSESSMENT  
PHYLOGENETIC TREE II

Name \_\_\_\_\_ period \_\_\_\_\_

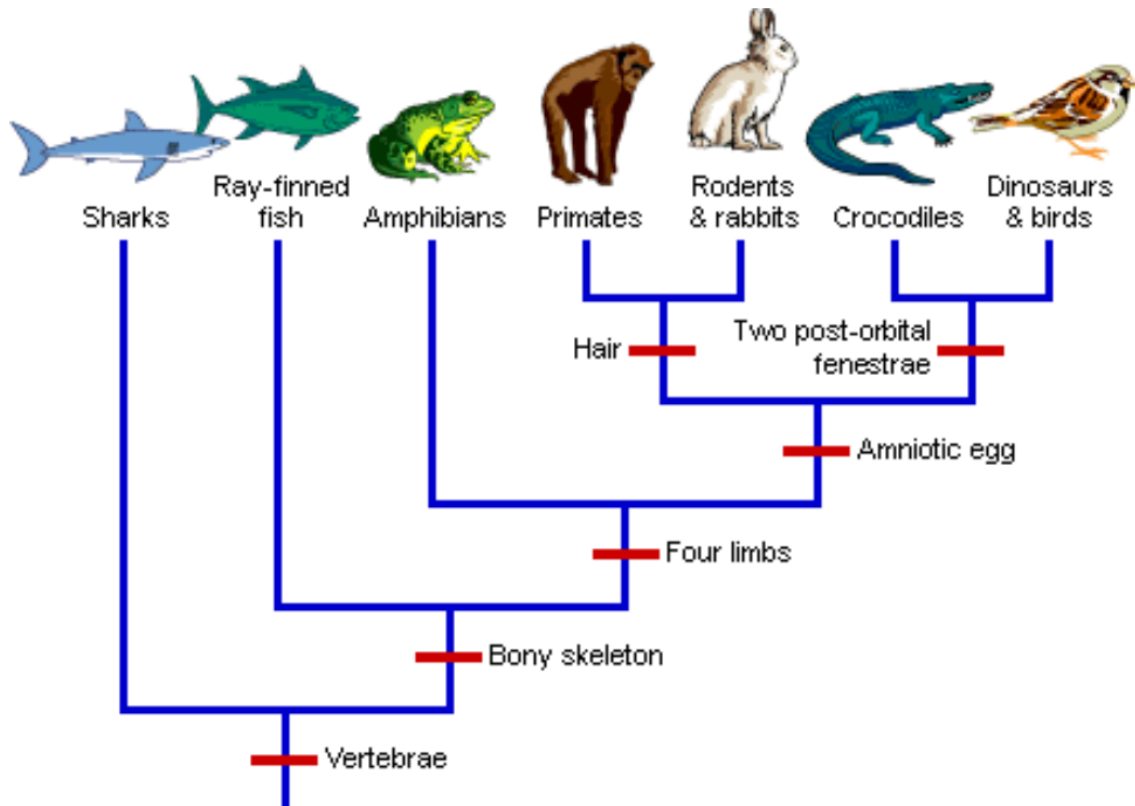

1. What characteristic differentiates sharks from all the other animals in the model above?
2. Which organism is most closely related to the rodents and rabbits?
3. What information in the model did you use to make that determination?
4. What Science and Engineering Practice are you using to answer these questions?
5. What crosscutting concepts are scientists relying on when they construct a chart like the one above?

APPENDIX N  
FORMATIVE ASSESSMENT  
PHYLOGENETIC TREE III

Name \_\_\_\_\_ period \_\_\_\_\_

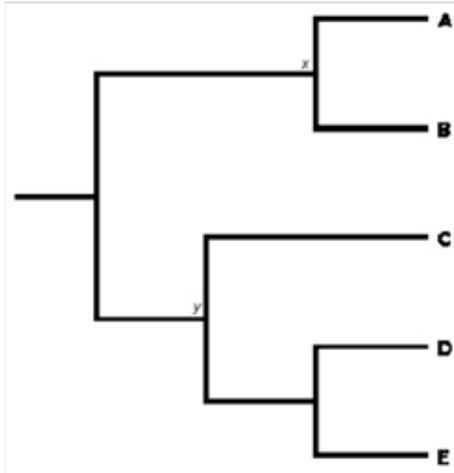

Put in the nodes (dots or slashes) where the changes in specialization would occur.

1. Which organism(s) would you consider to be the earliest in developmental history?
2. Why did you make that choice?
3. Which organism(s) would you consider to be the most evolutionarily advanced?
4. Why did you say that?
5. Which two organisms are most closely related: C and E or C and B?
6. Why did you say that?
7. What Science and Engineering Practices are you using to make the above decisions?
8. Which Crosscutting concepts are you employing?

APPENDIX O  
FORMATIVE ASSESSMENT  
EMBRYOLOGY

Name \_\_\_\_\_ period \_\_\_\_\_

Put the following organisms in a cladogram (on back), according to the similarities you can see in embryological development so that the most closely related are nearest to each other.

**HUMAN**

\_\_\_\_\_



**SALAMANDER**

\_\_\_\_\_



**PIG**

\_\_\_\_\_



**CHICKEN**

\_\_\_\_\_



**MONKEY**

\_\_\_\_\_



Give an example of two Crosscutting Concepts that are evident in the model above.

\_\_\_\_\_

\_\_\_\_\_

Which Science and Engineering Practices did you use when you were constructing your answer?

\_\_\_\_\_

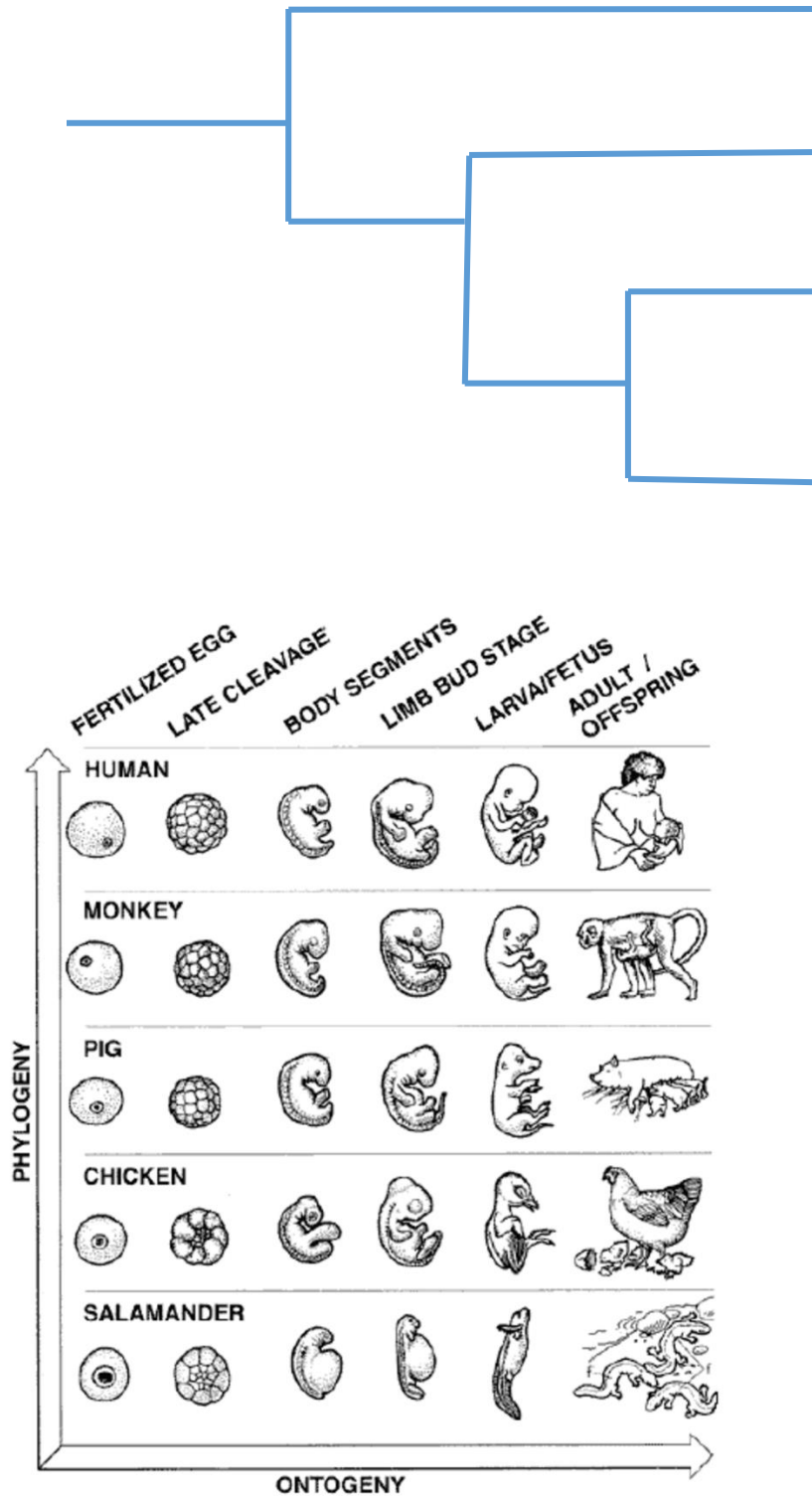



APPENDIX P  
FORMATIVE ASSESSMENT  
MUTATION AND NATURAL SELECTION

Name \_\_\_\_\_ period \_\_\_\_\_

Learning Target:

Use your notebook to help answer the following questions:

1. Draw and describe what a mutation is.
2. What happened to the walking stick population in each of the three environments in our simulation yesterday?

Bush:

Wood Chip:

Bamboo:

3. What Crosscutting Concepts were you using when you did the simulation yesterday?
4. What Science and Engineering Practices were you using when you did the simulation?
5. What CC's and SEP's are you using when you answer question number 2 above?

Crosscutting Concepts	Science and Engineering Practices

APPENDIX Q  
FORMATIVE ASSESSMENT  
PEDIGREE CHART

Name \_\_\_\_\_ period \_\_\_\_\_

Look carefully at the pedigree chart below, then answer the following questions.

Cystic Fibrosis is an autosomal recessive disease.

**AUTOSOMAL  
RECESSIVE**

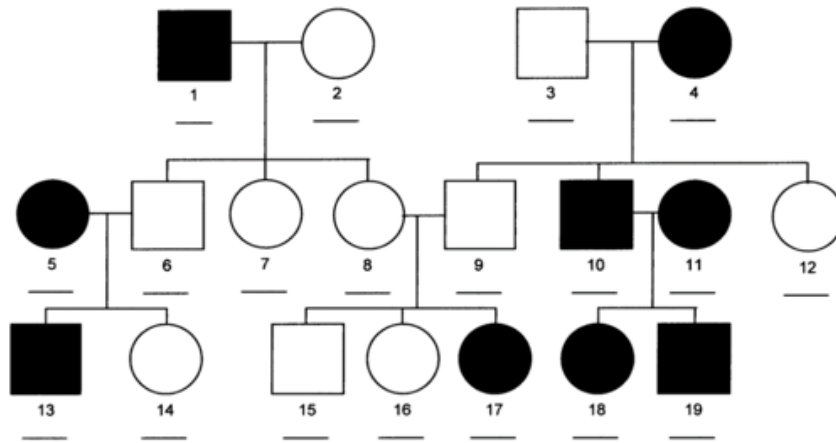

What is the relationship between the following people?

People	Relationship	Reason you could tell on chart
5 and 6		
6 and 8		
6 and 14		

How many people in generation III are not affected by this disease?

What CC are you using to answer the questions above?

What SEP's would you need to answer these questions?

<https://migrc.org/Library/AutosomalRecessive.html>

APPENDIX R  
FORMATIVE ASSESSMENT RUBRIC

Dimension being measured	0	1	2
Content	Could not identify	Partial success	Complete success
Science and Engineering Practice	Did not use vocabulary, examples	Partial success, vague	Complete, specific detail
Crosscutting Concept	No clear vocabulary, examples	Partial success, not connected well	Clear connections

APPENDIX S  
TEACHER OBSERVATION JOURNAL

## Teacher Observation Journal

Dates	Teacher Notes	Student Notes
1/3-6		
1/9-13		
1/17-20		
1/23-27		
1/30-2/3		
2/8-10		
2/13-17		
2/20-24	No School	
2/27-3/3		
3/6-9		